

## Contents

<b>1. GENERAL</b> .....	<b>3</b>
<b>2. CHARACTERISTICS</b> ..... <b>3</b>	
2.1 APPLICABLE STANDARDS .....	3
2.1.1 Safety class .....	3
2.1.2 EMC conformity .....	3
2.1.3 Ambient conditions .....	3
2.1.4 Mechanical conditions .....	3
2.1.5 Measurements at reference conditions .....	3
2.1.6 IEEE-488 interface .....	3
2.1.7 RS 232 interface .....	3
2.2 GENERAL SPECIFICATIONS .....	3
2.3 PARTICULAR SPECIFICATIONS .....	3
2.3.1 Accuracy .....	3
2.3.2 DC voltage mode .....	4
2.3.3 DC current mode .....	4
2.3.4 Specifications common to both modes .....	4
2.3.5 Additional specifications .....	4
2.3.6 RS 232 interface .....	5
2.3.7 IEEE-488.2 interface .....	5
<b>3. MEASUREMENT AND MAINTENANCE ACCESSORIES</b> ..... <b>5</b>	
3.1 DELIVERED WITH THE UNIT .....	5
3.2 DELIVERED IN EXTRA .....	5
<b>4. INSTRUCTIONS BEFORE USE</b> ..... <b>6</b>	
4.1 UNPACKING .....	6
4.2 RETURN .....	6
4.3 INSTRUCTIONS BEFORE SWITCHING ON .....	6
4.4 CONTROLS .....	6
4.4.1 Front panel .....	6
4.4.2 Rear panel .....	7
4.4.3 Tilt stand position .....	7
4.5 PANEL OR RACK MOUNTING .....	7
4.5.1 Panel cut-out .....	7
4.5.2 Panel mounting .....	7
4.6 CONNECTIONS .....	7
4.6.1 Voltage mode .....	7
4.6.2 Current mode .....	8
4.6.3 Trigger command .....	9
4.6.4 Safety terminal .....	9
4.6.5 RS 232 plug .....	9
<b>5. OPERATION</b> ..... <b>10</b>	
5.1 SAFETY PROVISIONS .....	10
5.1.1 In accordance with safety standards .....	10
5.1.2 Following instructions supplied in the accompanying documents .....	10
5.1.3 Taking measurements .....	10
5.1.4 Faults and abnormal constraints .....	10
5.1.5 Definitions .....	10
5.1.6 Maintenance .....	10
5.2 SWITCHING ON .....	11
5.3 ERROR MESSAGES .....	11
5.3.1 Display .....	11
5.3.2 Audible warning (beep) .....	11
5.4 USING THE SECONDARY FUNCTION KEY .....	11
5.5 SELECTING A RANGE IN AN OPERATING MODE .....	11
5.6 SELECTING THE 2-WIRE OR 4-WIRE CONFIGURATION .....	11
5.7 CHANGING THE EMITTED VALUE .....	11
5.7.1 Using the number keys .....	11
5.7.2 Using the arrow keys .....	12
5.7.3 Using the trigger command .....	12
5.7.4 Generation of programmed steps .....	12
5.7.5 Other possible evolutions of the signal .....	12
5.8 INVERSION OF POLARITY .....	12
5.9 STANDBY/OPERATION STATES .....	13
5.10 LIMITS AND PROTECTIONS .....	13
5.10.1 Emitted value limit .....	13
5.10.2 Safety limit of the internal supply voltage .....	13
5.11 MEMORIES .....	13
5.11.1 Storage .....	13
5.11.2 Recalling memory .....	13
5.11.3 Consecutive recall of memories - synthesizer .....	13
5.12 IEEE-488 AND RS 232 INTERFACES .....	14
REMOTE CONTROL .....	14
5.12.1 General .....	14
5.12.2 General on remote control syntax .....	14
5.12.3 SN 8310 remote commands .....	17
<b>6. PROGRAMMING</b> ..... <b>23</b>	
6.1 USING THE KEYBOARD FOR PROGRAMMING .....	23
6.2 ACCESSING THE FUNCTION AND CHOOSING THE PROGRAM .....	23
6.2.1 Direct access to the required program .....	23
6.2.2 Access to the required program by rotational selection of main menu .....	23
6.3 GENERAL PROCEDURE .....	24
6.4 GENERAL PROCESSING PROGRAMS .....	24
6.4.1 Language .....	24
6.4.2 Instrument identity .....	24
6.5 LIMIT PROGRAMS .....	25
6.5.1 Max. emitted value .....	25
6.5.2 Max. voltage delivered by the internal supply .....	25
6.6 SIGNAL EVOLUTION PROGRAMS .....	26
6.6.1 Steps .....	26
6.6.2 Synthesizer .....	27
6.7 INTERFACE .....	28
<b>7. MAINTENANCE</b> ..... <b>29</b>	
7.1 OPENING THE UPPER AND LOWER CASINGS .....	29
7.2 SETTING THE CASINGS BACK .....	29
7.3 CHANGING THE FUSE .....	29
7.4 230 V OR 115 V POWER SUPPLY .....	29
7.5 MAINTENANCE OF THE BATTERY .....	29
7.5.1 Usual operation .....	29
7.5.2 Storage .....	30
7.5.3 Replacing the battery .....	30
7.6 CONNECTING THE RS 232 AND IEEE-488 INTERFACES TO THE GROUND .....	30
7.7 CYCLIC CHECKING OF PERFORMANCES .....	30
7.8 RECALIBRATION .....	30
7.8.1 Principle .....	30
7.8.2 Method .....	30
7.8.3 Keyboard procedure .....	30
7.8.4 Calibration procedure from the RS 232 or IEEE-488 interfaces .....	31
<b>8. WARRANTY</b> ..... <b>31</b>	
<b>DECLARATION OF CONFORMITY</b> ..... <b>32</b>	



## 1. GENERAL

The SN 8310 calibrator represents a major advance in the concept of calibration of instruments measuring DC voltages and currents.

It supplies voltages from 100 nV DC to 110 V DC and currents from 1 nA DC to 110 mA DC with an accuracy of better than 0.002 % (20 ppm).

This instrument has been ergonomically designed for the user: simple, fast readout of values and functions on the lighted digit display, screen messages in English, 200 predetermined calibration values, automatic electronic calibration of the instrument.

The SN 8310 is remotely programmable using either RS 232 or IEEE-488 digital interface, easily integrated into a rack system, allowing it to be used in bench test sets.

The SN 8310 is available under the following references:

- SN 8310-1: Basic model (115/230 V power supply and RS 232).
- SN 8310-2: Basic model with battery and charger.
- SN 8310-3: Basic model with IEEE-488 interface.
- SN 8310-4: Basic model with battery, charger and IEEE-488 interface.

## 2. CHARACTERISTICS

### 2.1 APPLICABLE STANDARDS

#### 2.1.1 Safety class

In accordance with European Norm EN 61010-1.

Category: III, pollution 2.

Rated voltage: 150 V

**Note 1:** The safety provisions for the unit are given in paragraph 5.1.

**Note 2:** In order to maintain performances of the announced safety provisions, the measuring accessories must meet the European Norm EN 61010-2-031 and have adapted safety characteristics.

#### 2.1.2 EMC conformity

The unit performances meet the standards following:

Conducted and radiated disturbances: EN 55022/1994, class B.

Immunity: EN 50082-1/1992.

Radiated: IEC 801-3/1984. Conducted: IEC 801-4/1988.

Electrostatic discharges: IEC 801-2/1991.

#### 2.1.3 Ambient conditions

In accordance with IEC Publication 359 (national standards NF C 42-600, DIN 43745): operating category I.

Reference range: 23°C ± 1°C, relative humidity: 45 % to 75 %.

Normal operating range: 0°C to + 45°C, relative humidity: 20 % to 80 % non-condensing.

Operating range limits: 0°C to + 50°C, relative humidity: 10 % to 80 % non-condensing.

Limits for storage and transport: - 30°C to + 55°C (- 15°C to + 50°C for model with battery).

#### 2.1.4 Mechanical conditions

Protection according to IEC Publication 529 (national standard NF C 20-010): IP 40.

Shock according to European Norm EN 61010-1.

Vibrations according to IEC 68-2-6.

#### 2.1.5 Measurements at reference conditions

In accordance with IEC Publication 359 and IEC Publication 443 (national standard NF C 42-620).

#### 2.1.6 IEEE-488 interface

In accordance with IEC 625-1 and 625-2 Publications (national standards NF C 42-910 and NF C 42-911, DIN IEC 625-1 and DIN IEC 625-2) and American standard IEEE-488.2.

#### 2.1.7 RS 232 interface

In accordance with ANSI EIA-232-D-1986 standard.

## 2.2 GENERAL SPECIFICATIONS

- Bench-type instrument with carrying handle and power supply cord; one model with rechargeable battery pack.

- Usable in rack-mounting with accessories.

- Liquid crystal display, 11 alphanumeric characters (16 segments), 11,5 mm high with built-in lighting to display 1 100 000 counts, unit symbols and help messages.

- Languages available: French, English, German.

- 22-key keyboard for processing and programming.

- Audible warning (beep) of any incorrect operation when programming or processing.

- Storage of 200 calibration values in memory, generation of predetermined value increments, either manually or at programmable time intervals.

- Output terminals on front also duplicated at rear of the unit for rack usage.

- Power supply:  
230 V ± 10 %, 50-60 Hz (240 V + 6 %, - 10 % permissible).  
115 V ± 10 %, 50-60 Hz by internal switching.  
Consumption: 20 VA max.

- Optional battery pack with built-in charger.  
Life: from 3 to 8 hours depending on the operating mode and charge value with automatic disconnection of the supply when the battery is nearly discharged.  
Charging time: between 12 and 14 hours.

- Dimensions: 225 mm x 88 mm x 310 mm (overall width: 275 mm with handle).

- Weight: 2 kg (3 kg max. with battery and optional IEEE-488).

## 2.3 PARTICULAR SPECIFICATIONS

### 2.3.1 Accuracy

Stated accuracies are expressed in ± (n % rdg + C) with rdg = reading and C = constant expressed as a practical unit. They applied to instruments situated in the reference conditions defined elsewhere after warming up for one hour, the output signal having normal polarity (i.e. that of the terminals) and the 4-wire configuration validated (except over 100 mV range).

Operation for 30 seconds warrants signals at 0.0020 % of the value given by an heat-stabilized instrument and at 0.0002 % after 5 minutes.

## 2.3.2 DC voltage mode

### 2.3.2.1 Accuracy

Range	Emission range	Resolution	Accuracy	
			90 days	1 year
100 V	- 5.0000 V + 110.0000 V	100 $\mu$ V	0.0020 % + 200 $\mu$ V	0.004 % + 300 $\mu$ V
10 V	-1.10000 V + 11.00000 V	10 $\mu$ V	0.0020 % + 20 $\mu$ V	0.004 % + 30 $\mu$ V
1 V	- 0.110000 V + 1.100000 V	1 $\mu$ V	0.0025 % + 4 $\mu$ V	0.005 % + 6 $\mu$ V
100 mV ①	- 11.0000 mV + 110.0000 mV	100 nV	0.0035 % + 2 $\mu$ V	0.007 % + 2 $\mu$ V

① 2-wire configuration on SENSE terminals.

Linearity: 0.0003 % of range.

### 2.3.2.2 Stability, noise

Range	Stability DC	Noise 0.1 Hz - 10 Hz	Noise 10 Hz - 10 kHz
100 V	0.0001 % + 100 $\mu$ V	50 $\mu$ V peak to peak	600 $\mu$ V rms
10 V	0.0001 % + 10 $\mu$ V	5 $\mu$ V peak to peak	60 $\mu$ V rms
1 V	0.0001 % + 2 $\mu$ V	5 $\mu$ V peak to peak	60 $\mu$ V rms
100 mV ①	0.0001 % + 500 nV	500 nV peak to peak	10 $\mu$ V rms

① 2-wire configuration on SENSE terminals.

### 2.3.2.3 Other output specifications

Range	Compliance		Internal resistance
	Positive output	Negative output	
100 V	approx. 1.5 W max.	- 11 mA	< 10 m $\Omega$ ②
10 V	110 mA	- 11 mA	< 10 m $\Omega$ ②
1 V	110 mA	- 11 mA	< 10 m $\Omega$ ②
100 mV ①	-	-	99 $\Omega$

① 2-wire configuration on SENSE terminals.

② For output on front terminals using the 2-wire configuration. On rear terminals: 300 m $\Omega$ .

- 2-wire configuration via the SENSE terminals or 4-wire configuration configurable on keyboard.

- Connection for the 4-wire configuration: via the four front terminals or via the rear terminals for rack mounting. This connection is impossible over the 100 mV range.  
Max. permissible voltage drop in each current wire: 0.2 V.  
Current in the voltage wires: < 1 nA.

- When operating with inverted polarity, add influence on the voltage ranges which is < 0.3  $\mu$ V.

- Max. permissible capacitance at load terminals: 10  $\mu$ F.

- Protection against overloads and short-circuits: By means of an internal electronic limiter in current, voltage and power.

- Max. permissible overvoltage on the output terminals having normal polarity:  
. 100 mV range:  $\pm$  5 V (DC or peak).  
. other ranges: - 20 V and + 120 V (DC or peak).

- Temperature coefficient:  $\leq$  10 % of the accuracy per  $^{\circ}$ C.

- Common mode rejection: > 140 dB.

## 2.3.3 DC current mode

### 2.3.3.1 Accuracy

Range	Emission range	Resolution	Accuracy ( i  > 0.01 % of range)	
			90 days	1 year
100 mA	- 11.0000 mA + 110.0000 mA	100 nA	0.008 % + 400 nA	0.010 % + 800 nA
10 mA	- 1.10000 mA + 11.00000 mA	10 nA	0.008 % + 40 nA	0.010 % + 80 nA
1 mA	- 0.110000 mA + 1.100000 mA	1 nA	0.008 % + 4 nA	0.010 % + 8 nA

Linearity: 0.0003 % of range.

### 2.3.3.2 Stability, noise

Range	Stability DC	Noise 0.1 Hz - 10 Hz	Noise 10 Hz - 10 kHz
100 mA	0.0003 % + 300 nA	500 nA peak to peak	1 $\mu$ A rms
10 mA	0.0003 % + 30 nA	50 nA peak to peak	100 nA rms
1 mA	0.0003 % + 3 nA	5 nA peak to peak	10 nA rms

### 2.3.3.3 Other output specifications

Range	Compliance	
	Positive output	Negative output
100 mA	approx. 1.5 W max.	- 5 V
10 mA	110 V	- 10 V
1 mA	110 V	- 10 V

- Max. output voltage: approx. 120 V, or approx. 25 V by programming.

- Source resistance: > 100 M $\Omega$ .

- Protection against application of an external voltage (normal polarity): - 20 V and + 120 V (DC or peak).

- Temperature coefficient:  $\leq$  10 % of the accuracy per  $^{\circ}$ C.

## 2.3.4 Specifications common to both modes

- Dynamic behavior on ohmic load.

. Recovery time: < 3 seconds to meet the specified accuracies, plus one second when changing range or inverting polarity.  
. Overshoot: < 5 % of the signal variation.

- Emission or standby key.

- Key to invert polarity of the output signal.

## 2.3.5 Additional specifications

### 2.3.5.1 Limitation of the emitted value by programming

By programming, the absolute value of the emitted signal can be limited:

- up to 110 V in voltage mode,  
- up to 110 mA in current mode.

This limit is independent of the 25 V safety one concerning the internal voltage generator and of the 1.5 W output power.

### 2.3.5.2 Increment command

Using the keyboard, positive or negative steps cause the emitted signal to increase or decrease:

- either by one unit for the required digit selectable by the keyboard,  
- or by any value known in quantity and sign and through a particular range thanks to the **STEPS ?** program.

Changing can be performed either step by step or automatically by constant pressing of the command key.

The **STEPS ?** program also runs automatic step cycles from 1 to 1.2.10<sup>6</sup>. The interval between two steps is also selectable between 0.1 s and 500 s.

### 2.3.5.3 Storage of values to be emitted - synthesizer

The unit can store 100 voltage values and 100 current values previously entered on the keyboard. Then, these values can be recalled, either one by one by using their serial number, or automatically and successively by using the **SYNTHE. ?** program which enables:

- to scan the next memories,  
- to select the interval between two consecutive values (from 0.1 s to 500 s),  
- to select the number of cycles to be performed (from 1 to 65 000).

#### 2.3.5.4 Trigger command

A short-circuit between two terminals located at rear of the unit by using a contact free of potential (dry contact or semiconductor: 5 V, 0.1 mA) remotely triggers:

- either the positive increasing of the emitted signal (by one unit for the selected digit),
- or the **STEPS ?** program,
- or the **SYNTHE. ?** program.

#### 2.3.6 RS 232 interface

Available at rear of the unit on a 9-pin SUB-D female connector.

A key returns the unit to LOCAL mode.

##### Interface specifications:

- Transmission rate: 300, 600, 1 200, 2 400, 4 800, 9 600, 19 200 bauds.
- Character format: 7 or 8 bits with 1 or 2 stop bits.
- Parity: even, odd, ignore, no parity.
- Protocol: XON/XOFF, DTR/CTS or no protocol.

These parameters are programmed on the keyboard and stored in a saved memory.

Refer to paragraph 5.12 for more details.

#### 2.3.7 IEEE-488.2 interface

Available on a standardized 24-pin plug.

The address of the unit is entered on the keyboard and kept in saved memory (31 addresses available).

A key returns the unit to LOCAL mode.

Both IEEE and RS 232 circuits are set to the same potential, together with the trigger command.

Functions available:

**AH1 SH1 T6 L4 SR1 RL1 PP0 DC1 DT0 C0 E2**

Refer to paragraph 5.12 for more details.

### 3. MEASUREMENT AND MAINTENANCE ACCESSORIES

#### 3.1 DELIVERED WITH THE UNIT

- A power cord.
- An instruction manual.

#### 3.2 DELIVERED IN EXTRA

<b>AN 5883</b>	Right-angle brackets for panel mounting.
<b>AN 5884</b>	3 U panel and right-angle brackets for rack mounting.
<b>ER 48289-009</b>	9-pin male SUB-D connector for the RS plug of the SN 8310.
<b>AN 5874</b>	RS 232 cable, 2 m long, for connection to a microcomputer (PC XT, PC AT or compatible equipped with a 25-pin male connector).
<b>AN 5875</b>	RS 232 cable, 2 m long, for connection to a microcomputer (PC XT, PC AT or compatible equipped with a 9-pin male connector).
<b>AN 5894</b>	9-pin/25 pin adapting cable, 20 cm long, for microcomputer.
<b>AN 5836</b>	IEEE-488 cable, 2 m long, for connection or extension.
<b>LC 104</b>	Software for loading and changing memories.
<b>AN 6901</b>	Casing for transport.

## 4. INSTRUCTIONS BEFORE USE

### 4.1 UNPACKING

The unit is mechanically and electrically checked before dispatch. Every precaution has been taken to ensure that it reaches the user undamaged.

Nevertheless, it is advisable to carry out a quick check for any damage that may have occurred in transit. If any such damage is found it should be reported to the shipper.

### 4.2 RETURN

If the unit is to be returned, the original packaging should be used and a note explaining as clearly as possible the reasons for returning it should be included.

### 4.3 INSTRUCTIONS BEFORE SWITCHING ON

Before using the unit with all the necessary safety, the user must read **carefully** chapter 5 which deals with safety provisions.

### 4.4 CONTROLS

#### 4.4.1 Front panel



#### Liquid crystal display:

- 11 characters, 11.5 mm high, indicating the emitted value, polarity (7 digits with sign + implied) and mV, V and mA unit symbols.
- At left, one function symbol **REM** and one battery state symbol **BAT**.
- In the middle, one symbol **LIM** of the emitted signal limitation.
- At right, one function symbol **EMIS** and one symbol indicating either the 2-wire configuration (-/-) or the 4-wire configuration (-////-).

#### Terminals:

- Five safety terminals for 4 mm plugs:
- 4 terminals supplying the output signal either in 2-wire or 4-wire configuration (see § 4.6).
  - 1 ground terminal internally connected to the safety conductor of the power cord.

#### Keyboard:

22-key keyboard and one power indicator:

#### ➡ Keys with black marking (or associated with a black marking)

##### Digital keys:

- 0 to 9; - and .** Input of number and sign (sign + implied).
- ENT** Confirmation of number, prompt or program.
- CL** Deletion of a number.  
Stopping of automatic program.

##### Increasing/decreasing keys:

These keys are the four triangles represented by four arrows in this present publication.

← and → Selection of the digit (figure) to be increased or decreased.

↑: Increasing.

↓: Decreasing.

##### Function keys:

- STBY** Standby. The value displayed is not available on the terminals.  
The unit emits zero.
- OPER** Operation. The value displayed is available on the terminals.
- RM** Recalls memory.
- LOC** Returns to local mode.
- I/O** Switches the unit ON or OFF.

#### ➡ Blue key and keys associated with a blue marking

##### Secondary function keys (shift):

-  The blue key enables use of all the blue functions (including PROGramming).

##### Range changing keys:

**100mV, 1V, 10V, 100 V:** Changing of range in voltage mode.

**1mA, 10mA, 100mA:** Changing of range in current mode.

##### Other keys:

- INV** Inversion of the polarity at terminals of the unit.
- //- -////- Selection of the 2-wire or 4-wire configuration.
- MEM** Storage in memory.
- ☆ Switches the display lighting ON or OFF.

#### 4.4.2 Rear panel

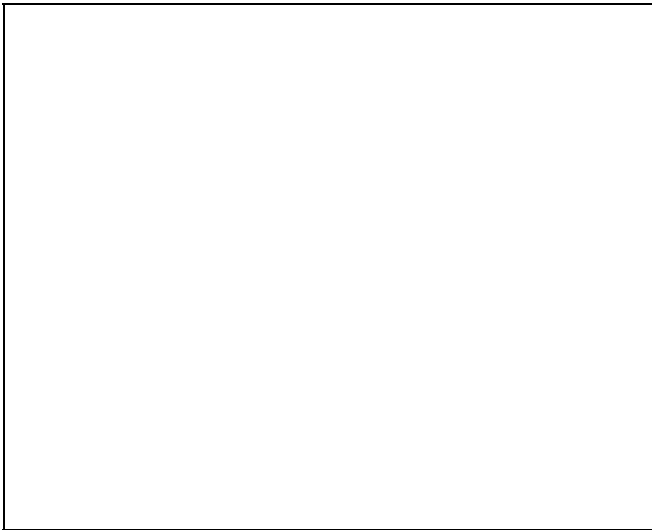

From left to right:

- The 9-pin female RS 232 connector (see § 4.5.6 and 5.12).
- The optional 24-pin IEEE 488 connector (see § 5.12).
- The trigger command (see § 4.6.3 and 5.7.3).
- The  $\oplus$  terminal for connection to a safety conductor when the unit is battery-operated (see § 4.6.4).
- The plug to connect the power cord.
- The terminal board to connect the output signal (see § 4.6).

#### 4.4.3 Tilt stand position

To change the position of the tilt stand:

- Press the two yellow knobs and turn the stand.
- Release the knobs and turn the stand up to its automatic interlocking. The angle between each position is 30°.

### 4.5 PANEL OR RACK MOUNTING

The panel or rack mounting is made by means of the right-angle brackets delivered the AN 5883 kit.

The accessory AN 5884 is used for the 3 U rack mounting and also includes the right-angle brackets above.

#### 4.5.1 Panel cut-out



Dimensions in mm

#### 4.5.2 Panel mounting

- Remove the carrying handle by unscrewing the four screws.
- Use the four holes to fix the two right-angle brackets by means of the 4 countersunk-head screws.
- Insert the unit through the panel cut-out and fix it by using the two M6 screws.

### 4.6 CONNECTIONS

#### 4.6.1 Voltage mode

##### 4.6.1.1 4-wire configuration

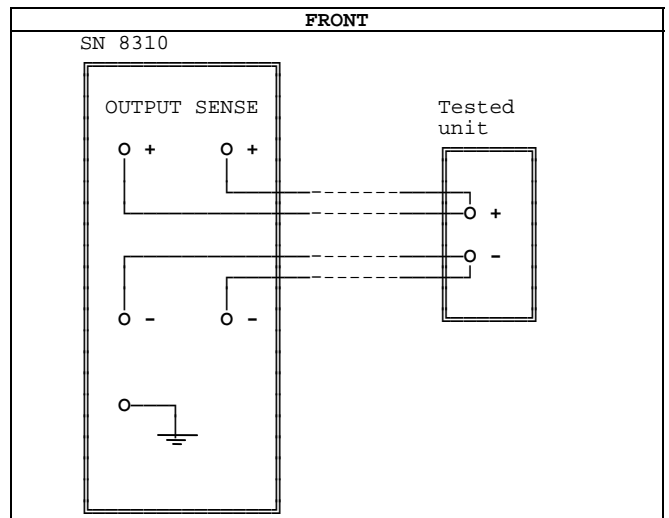

or

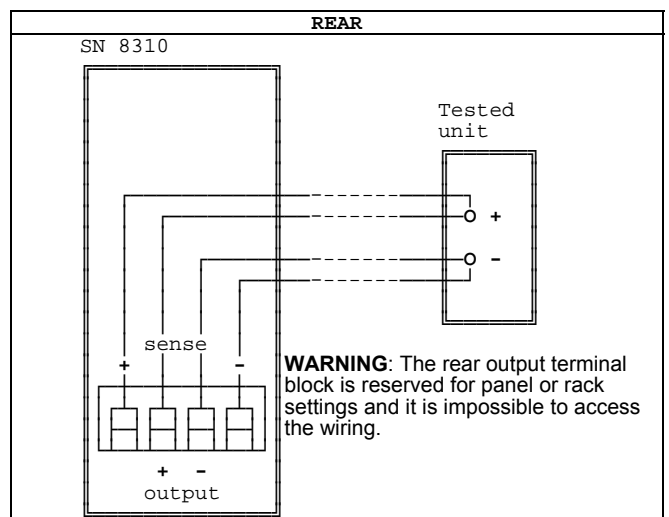

 **Avoid any stray e.m.f and minimize the resistance of the connection wires to the sense terminals.**

4.6.1.2 2-WIRE configuration

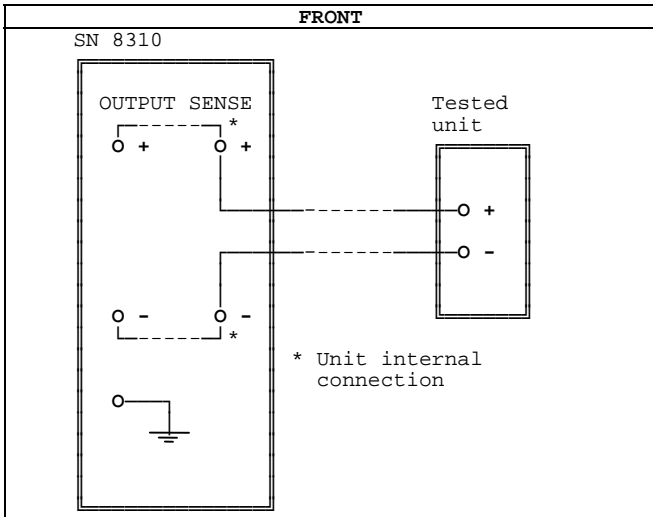

or

4.6.2 Current mode

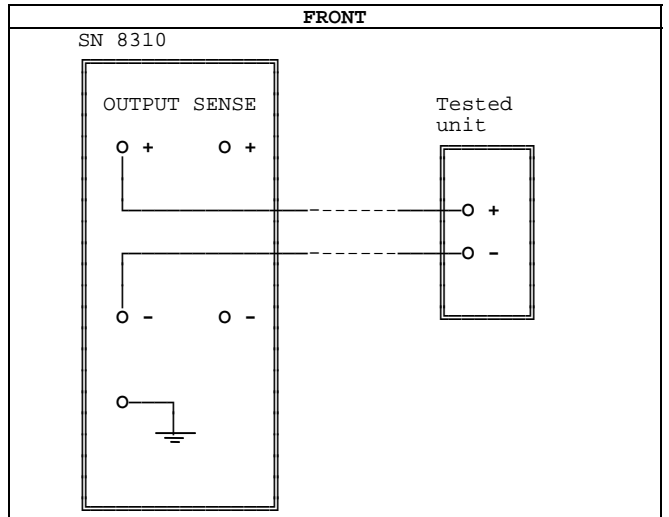

or

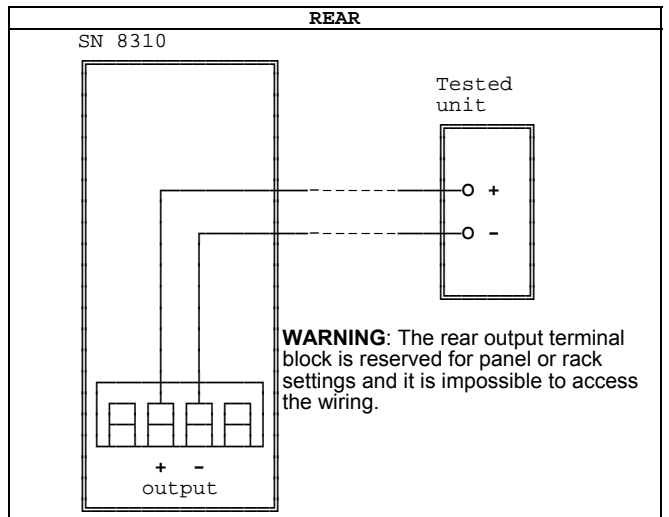
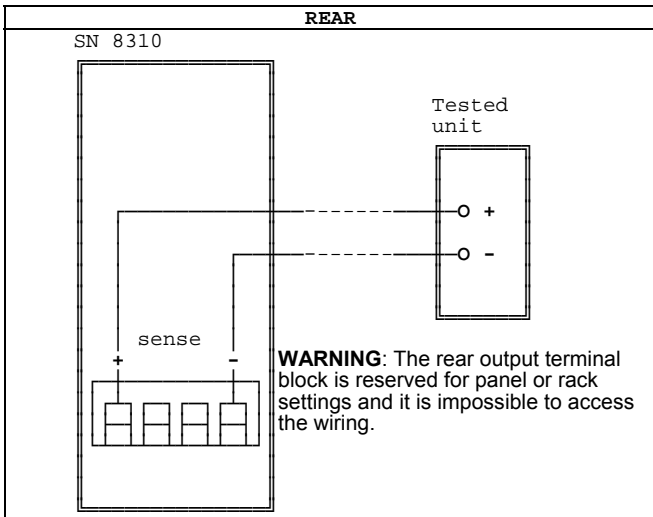

With the 2-wire configuration, voltage present on SENSE terminals of the SN 8310 is that programmed. Select the connection wires according to the specifications of the tested unit.

To get the specified characteristics, preferably use:

- the front 4-wire connection with the 100 V, 10 V and 1 V ranges,
- over the 100 mV range, only the 2-wire configuration is usable. Over this range the internal resistance should not exceed 99 Ω.
- the direct polarities of the output signals as stated on diagrams above.



### 4.6.3 Trigger command

Connect the **décl. trig.** terminals at rear to an external N.O contact free of potential: dry contact or semiconductor.

If using a semiconductor, respect the indicated polarities (internal source 5 V, 47 kΩ).

The  negative terminal is connected to the safety ground.

### 4.6.4 Safety terminal

This  terminal near the trigger command is internally connected to the front ground terminal and to the safety conductor of the power cord.

It then can be used when the unit is panel-mounted and operates from the rear terminals and/or when the unit is battery-operated, without power cord, and needs to be connected to a safety conductor.

### 4.6.5 RS 232 plug

Use a 9-pin male SUB-D connector (ER 48289-009 delivered in extra) or one of the offered cables:

**AN 5874** for computer equipped with a 25-pin male SUB-D connector.

**AN 5875** for computer equipped with a 9-pin male SUB-D connector.

Connections are as follows:

SN 8310 side male connector	9-pins	Link	Computer side female connector	
			25-pins (AN 5874)	9-pins (AN 5875)
CD	1	_____ > _____	8	1
RD	2	_____ > _____	3	2
TD	3	_____ < _____	2	3
DTR	4	_____ < _____	20	4
Common	5	_____	7	5
DSR	6	_____ > _____	6	6
RTS	7	_____ < _____	4	7
CTS	8	_____ > _____	5	8
RI	9	_____ > _____	22	9

*Remember that the RS 232 circuits are to the potential of the trigger command and IEEE circuits.*

**N.B:**

- Upon receiving the unit, pin 5 (Common) is connected to the ground.
- Pins 1, 7 and 9 are free from potential on the SN 8310 side.
- Line DSR is set to 1 permanently (+ 9 V).

## 5. OPERATION

### 5.1 SAFETY PROVISIONS

#### 5.1.1 In accordance with safety standards

The unit is constructed and tested according to EN 61010-1: safety rules for the electronic measuring instruments.

This instruction manual contains information and advice that users must follow to be protected against electrical shocks and to ensure the reliability of the unit in order to maintain it in a satisfactory state with regard to safety.

The unit may occasionally be exposed to temperatures between 0°C and + 50°C without its safety features being compromised. It should not be used at altitudes above 2 500 m.

Use the power cord supplied with the unit and connect it to a standardized plug equipped with a safety conductor connected to the earth and meeting the CEE 7 specifications.

This cord should not be disconnected in presence of dangerous voltage on the output terminals, except the model equipped with the built-in battery where one of the unit terminals  should be earthed.

#### 5.1.2 Following instructions supplied in the accompanying documents

The unit is constructed to operate under safety conditions if the instructions supplied in the accompanying documents are followed. Any usage, except those described, may reduce the safety of the operator and then, becomes dangerous and prohibited.

#### 5.1.3 Taking measurements

The test leads must meet the max. voltage delivered by the unit which is 120 V DC. They must be in good condition and should be changed if there is any evidence of deterioration (insulation split burnt, etc...).

Capacitors located in the operating circuits may remain charged even after they have been disconnected from the SN 8310 and do reset the output signal to zero (STBY key).

Never exceed the safety limit values indicated in the specifications and never connect the unit to a live circuit.

#### 5.1.4 Faults and abnormal constraints

Should there be any indication that the protection of the instrument has been compromised, it should be taken out of service and steps taken to prevent it being used inadvertently.

The protection may have been compromised in the following cases, for example:











- the instrument is obviously damaged,
- the instrument is no longer capable of taking accurate measurements,
- the instrument has been stored under unfavorable conditions,
- the instrument has been subject to severe stresses during shipment.

### 5.1.5 Definitions

#### 5.1.5.1 Definition of the installation category

This is also called overvoltage category. It's the installation classification according to standardized limits for transient overvoltages (IEC Publication 664). Level of these limits depends on the nominal line voltage, regarding the earth, which is present in the unit environment. The Publication has 4 levels of increasing voltages, from CAT I to CAT IV.

#### 5.1.5.2 Table of the symbols used

Symbol	Description
	Alternating current.
	Direct current.
	Direct and alternating current.
	Measurement earth terminal.
	Protective conductor terminal.
	Power ON.
	Power OFF.
	Double insulation.
	Risk of electric shock.
	Warning: see the accompanying documents.

#### 5.1.6 Maintenance

The unit should be reassembled as explained in the instruction manual. Any incomplete or bad reassemble may be dangerous for the safety of the operator.

The responsible body must check at regular time interval that all the components ensuring safety are not subject to wear and undertake all the necessary steps for preventive operations. Refer to chapter 7.

Before opening of the casing, make sure that the instrument is disconnected from any dangerous voltage source and that there is no more output signal supplied.

The replacement fuses must be of the appropriate type and rating, see § 7.3. The use of makeshift fuses and short-circuiting of the fuse holder contacts are strictly prohibited.

The instrument should not be opened up for adjustment, maintenance or repair when live unless this is absolutely essential, in which case this work should be carried out only by **appropriately qualified personnel advised of the risk entailed.**

## 5.2 SWITCHING ON

- Make sure that the voltage meets the one indicated at rear of the unit.
- Connect the power cord. The indicator "~" comes on indicating that the instrument is powered.

*N.B: The model with battery pack only requires connection to the power supply when the **BAT** symbol appears at left of the display indicating that the battery is to be recharged. The unit can be used but the battery should be always recharged with the unit switched off (see § 7.5).*

- Press **I/O**: the unit is powered, performs an initialization procedure during a few seconds, then switches on 10 V range.

The symbol **EMIS** indicates that the calibrator emits the displayed quantity, i.e. 0 V at switching on.  
The symbol **-/-** indicates that the calibrator is set to the 2-wire configuration.

 **The unit is ready to be used after switching on for 30 seconds (see 2.3.1).**

- If required check the software edition, for that successively press:

 **PROG** **PROG** and **ENT**

The instrument serial number appears for a few seconds followed by software edition which must correspond to that stated in this publication, page 1.

## 5.3 ERROR MESSAGES

During operation, some errors are displayed together with emission of an audible warning (beep).

### 5.3.1 Display

> <b>RANGE</b>	The requested value exceeds the range limits.
> <b>LIMIT</b>	The requested value exceeds the programmed limits.
> <b>025.0000 V</b>	The requested value exceeds the max. voltage of the internal supply limited to 25 V by programming.

Display of these messages is associated with emission of a beep.

<b>EMIS</b> blinking at right of the display	The emitted quantity is not the displayed value. Examples: - load resistance too high in current emission, - requested current too high in voltage emission.
---	---

### 5.3.2 Audible warning (beep)

A beep is emitted each time:

- a procedure needs consecutive pressings of several keys (input of a numerical value for example) and that execution of this procedure has stopped for more than four seconds,
- an operation cannot be taken into account.

In both cases, the unit returns to initial state.

## 5.4 USING THE SECONDARY FUNCTION KEY



The blue key  enables the following functions:

- Selection of the operating mode and range (see § 5.5).
- Selection of the 2-wire or 4-wire configuration (see 5.6).
- Inversion of polarity (see § 5.8).
- Storage in memory (see § 5.11.1).
- Programming (see chapter 6).
- Display lighting (see below).

Since the  key is pressed, the letter **S** (Shift) appears at left of the display giving access to one of the functions described above.

If there is no function called within four seconds, the unit returns to the previous state and emits the audible warning (see § 5.3).

### USING THE KEY TO LIGHT THE DISPLAY:

- Press  **S** appears at left of the display.
- Press  **☆** The display lights up and **S** disappears.

Repeat to switch the lighting off.

## 5.5 SELECTING A RANGE IN AN OPERATING MODE

At switching on, the unit is always in voltage mode on the 10 V range (see § 5.2) with the 2-wire configuration.

### To select (or change) a range:

- Press 
- Press **100mV**, **1V**, **10V**, **100V** or **1mA**, **10mA**, **100mA** depending on the range selected in the operating mode.

*N.B: Changing a range gives:*

- *direct polarity of the signal,*
- *zero value signal.*

## 5.6 SELECTING THE 2-WIRE OR 4-WIRE CONFIGURATION

At switching on, the unit is always set to the 2-wire configuration. The OUTPUT and SENSE terminals are connected internally.

### To select (or change) the configuration:

- Press 
- Press **-///-** to switch to the 4-wire or **-/-** to switch to the 2-wire configuration.

*N.B: Over the 100 mV range, the 2-wire configuration is forced and procedure above has no effect.*

## 5.7 CHANGING THE EMITTED VALUE

### 5.7.1 Using the number keys

#### Example:

0.975438 V to be emitted. The range has been selected (see § 5.5).

- Press **. 9 7 5 4 3 8**.
- Confirm with **ENT**.

**N.B:** To emit a negative value, press **-** key first.

### 5.7.2 Using the arrow keys

#### Example:

Changing from 0.975438 V to 0.979438.

The blinking figure indicates that it can be increased or decreased.

- Press ← (or →) to select the figure to be changed.

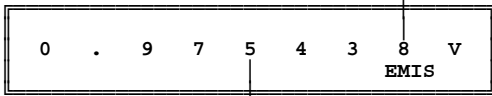

Here, after three pressings of ← key, the figure 5 blinks to indicate that it can be changed.

- Press ↑ (or ↓) to increase (or decrease) the selected figure.  
A prolonged pressing of ↑ (or ↓) continually increases (or decreases) the selected figure.

### 5.7.3 Using the trigger command

Same function as the ↑ key.

Each closing of an external contact connected to the **trig.** terminal board, causes the selected figure to be increased by one unit (see § 4.4.2 and 4.6.3).

Closing of this contact also triggers execution of the **STEPS ?** program (see § 5.7.4) or **SYNTHE. ?** program (see § 5.11.3) in manual mode, as well as the memory recalls (see § 5.11.2).

*N.B:* Decreasing the signal from the trigger command is not possible, except by programming of a negative step by the **STEPS ?** program (see § 6.6.1).

*In the same way, recalling the memories can only be performed by their increasing serial number.*

### 5.7.4 Generation of programmed steps

The generation of programmed steps is made by the **STEPS ?** program (see § 6.6.1) which enables you to program and store in nonvolatile memory all the signal evolution parameters such as shown in figure below.

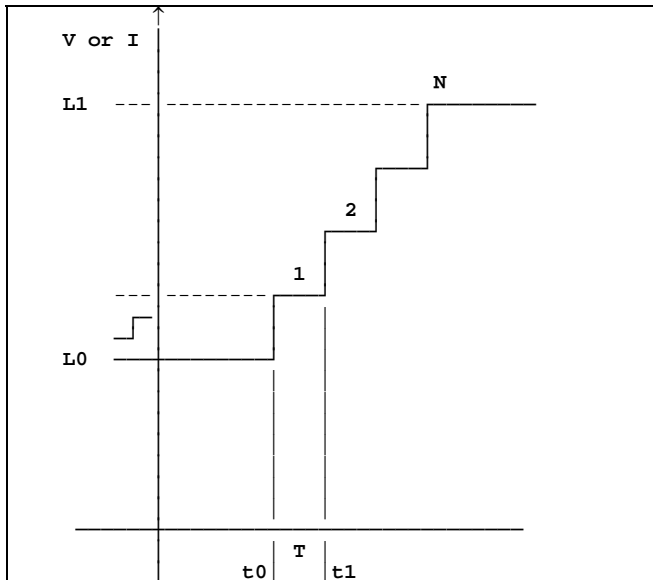

▭ is the step value (see N.B 1, next column).

T is the time interval between two consecutive steps.

N is the number of steps (whole number) forming the cycle.

Steps can be generated one by one, manually, or automatically by the two T and N parameters.

Since the step generation function is enabled in the program, the ▭ symbol appears at left of the display.

In that state, it is possible to:

- change the range (see § 5.5).
- set the initial level **L0** by means of the number keys (see § 5.7.1) or recall a memory (see § 5.11).
- toggle to standby or operation state (see § 5.9).
- generate steps either manually or automatically (see below).

#### 5.7.4.1 Manual generation

First, the manual generation and positive step should be programmed (see N.B 2).

- Press ↑ (or ↓) to increase (or decrease) the signal from the programmed value (see N.B 3).  
A prolonged pressing of ↑ (or ↓) continually increases (or decreases) the signal per steps from the programmed value.

#### 5.7.4.2 Automatic generation

First, the automatic generation, signal evolution parameters and positive step should be programmed (see N.B 2).

- Press ↑ (or ↓) to start generation of increasing steps (or decreasing steps) according to the programmed parameters (see N.B 3).
- Press **CL** key to stop the cycle.
- The cycle being ended or stopped, press ↑ (or ↓) again to restart generation of increasing steps (or decreasing steps) according to the same parameters.

*N.B:*

1 - The value of a step is the unit of the selected range.

Example: A 0.01 step equals:

- 0.01 mA, i.e. 10 μA over the three "milliammeter" ranges.
- 0.01 mV, i.e. 10 μV over the 100 mV range.
- 0.01 V, i.e. 10 mV over the three "volt" ranges.

2 - If the programmed step is negative, action on ↑ and ↓ is inverted.

3 - Generation of steps can be performed from the trigger command (see § 5.7.3).

### 5.7.5 Other possible evolutions of the signal

They concern usage of the memories where the consecutive recall, either manual or automatic, enables evolution of the output signal in both operating modes.  
Refer to § 5.11 for more details.

### 5.8 INVERSION OF POLARITY

The polarity of the output terminals can be internally inverted with no change for the connections.

- Press .
- Press **INV.** Symbol **I** appears at left of the display. The polarity is inverted.

To return to normal state, press **INV.** Symbol **I** disappears.

Return to normal polarity is automatic when changing range (see § 5.5).

## 5.9 STANDBY/OPERATION STATES

- Press **STBY** to switch to standby state. The symbol **EMIS** disappears. The unit emits zero.

*N.B: Standby state enables to change a quantity or recall a memory.*

- Press **OPER** to switch to operation state. The symbol **EMIS** appears. The displayed quantity is emitted.

## 5.10 LIMITS AND PROTECTIONS

In order to protect the external circuits, the emitted signal can be limited in voltage and/or current as well as the internal supply of the unit.

These limits are specified by the programming (see § 6.5). When one of these limits is activated, the symbol **LIM** appears on top of the display.

### 5.10.1 Emitted value limit

The **MAX. VALUE ?** program enables limit of the voltage and/or current (see § 6.5.1).

When this function is activated, any overlimit, occurring when changing a value, displays the **> LIMIT** error message (see § 5.3).

### 5.10.2 Safety limit of the internal supply voltage

By default, the internal voltage source of the unit is approximately 120 V.

The **LIM 25 V ?** program enables limit of this value to approximately 25 V (see § 6.5.2) when activated. In that case, the max. programmable voltage is limited to approximately 25 V.

Any overlimit displays the **> 025.0000 V** error message (see § 5.3).

## 5.11 MEMORIES

The unit has 100 memories in voltage mode and 100 memories in current mode. These memories, in both groups, bear serial numbers from 00 to 99 and they can be used either in standby or operation state (see § 5.9).

### 5.11.1 Storage

- Dial the value to be stored in the selected range (see § 5.7). This value can be emitted by pressing **ENT**.

- Press **MEM**.

- Press **MEM**. **Symbol M appears at left of the display.**

- Dial the memory number (two figures necessary). **Symbol M disappears. The value is stored.**

### 5.11.2 Recalling memory

- If required, switch to the range corresponding to the memory to be recalled.
- Press **RM**. **Symbol RM appears at left of the display.** The quantity recalled is displayed.
- Dial the memory number (two figures necessary). **Symbol RM disappears. The quantity recalled is displayed.**

*N.B: If an error message occurs (see § 5.3), the unit returns to the previous state.*

### 5.11.3 Consecutive recall of memories - synthesizer

This is done by the **SYNTHE. ?** program (see § 6.6.2) which enables you to program and store in nonvolatile memory:

- the first memory number recalled **1- MEM**,
- the last memory number recalled **2- MEM**,
- the time between each consecutive recall **T**,
- the number of cycles **N**.

#### Before starting the program:

- if required, change for the operation state (see § 5.9),
- switch to the range compatible with the content of the memories recalled.

#### To execute the program:

- open the program,
- change the parameters (if desired),
- then, continue as indicated below.

#### 5.11.3.1 Manual recall

The manual recall has been programmed.

When execution starts, the first memory is recalled and its serial number appears at left of the display.

Recalling other memories is made by means of the  $\uparrow$  or  $\downarrow$  keys on a rotational selection as explained below.

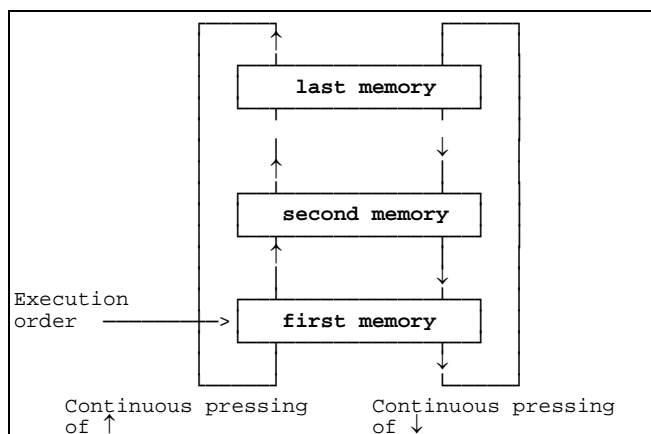

To exit, press **CL**.

*N.B: The manual recall can be performed from the trigger command (see § 5.7.3).*

#### 5.11.3.2 Automatic recall

The automatic recall and the four parameters stated above have been programmed.

When execution starts, the first memory is recalled and its serial number appears at left of the display.

Depending on the time interval programmed, the second one is recalled, then the third and so on etc..., until the last one.

If several cycles have been programmed (**N > 1**), the unit runs a new cycle.

To stop execution and exit from the program at any time, press **CL**.

At program exit (end of execution or stop) the emitted signal is that of the last memory recalled.

## 5.12 IEEE-488 AND RS 232 INTERFACES REMOTE CONTROL

### 5.12.1 General

The SN 8310 can operate under remote control of an instrument controller, a computer or a terminal, either via the asynchronous serial link standard delivered with all the units (RS 232), or via the optional IEEE-488 bus if ordered.

For convenience in text following, any instrument able to manage remote control will be called controller.

The IEEE-488 interface of the SN 8310 provides the following functions:

#### AH1 SH1 T6 L4 SR1 RL1 PP0 DC1 DT0 C0 E2

Selection of the remote control mode and specifications should be programmed on the keyboard (see § 6.7).

The commands are similar to both modes, except:

- that the IEEE-488 mode only operates when the SN 8310 is connected to the power supply.
- that in RS 232 mode:
  - . remote control is possible when the unit is battery-powered,
  - . commands REM, LLO and LOC replace the equivalent IEEE-488 bus messages,
  - . there is no service request (SRQ) capability.
  - . the IEEE-488 bus handshake is replaced by a protocol.

### 5.12.2 General on remote control syntax

The SN 8310 commands meet the IEEE-488.2 standard.

#### 5.12.2.1 Command messages

The controller controls the SN 8310 by means of **command messages**. These messages can contain several elementary commands separated by <;> (3B in hexadecimal or 59 in decimal).

A message command must contain a **terminator** which is:

- either character <LF> (0A in hexadecimal or 10 in decimal),
- or <EOI> message of the IEEE-488 bus (EOI line active during the last character),
- or <LF + EOI>.

In RS 232 mode, the terminator is always <LF>.

A command message can be written either with CAPITAL or small characters.

#### Command message syntax

COMMAND1;COMMAND2;...;COMMANDn<EOI> or <LF> or <LF + EOI>

An elementary command, called below **command**, is composed of an **header** followed, if required, by one or several **arguments** specifying the command.

One **space** (20 in hexadecimal or 32 in decimal) must be inserted between the header and the arguments and <,> (2C in hexadecimal or 44 in decimal) are required between arguments.

All the other spaces are optional and have no effect.

The headers of commands meeting the IEEE-488.2 standard always begin with the <\*> character.

#### Command syntax

HEADER ARGUMENT1,ARGUMENT2,...,ARGUMENTn

The SN 8310 recognizes two types of arguments: the **decimals** and **mnemonics**.

#### Decimals:

The decimals are used to specify either a whole or fractional numerical value. They are composed of a mantissa and optional exponent and can be followed by an optional **suffix** if required.

The mantissa is a whole or fractional number (whole and fractional parts separated by <.>), with or without sign, and may have up to 255 characters (non-significant head zeroes excluded).

The exponent is a whole number of four figures and may range from - 3 200 and + 3 200, with or without sign.

Mantissa and exponent are separated by the character <e> or <E>. Any space before or after <e> or <E> has no effect.

The suffix associates a unit (or a multiple or submultiple) to the numerical value.

The SN 8310 recognizes:

- voltage: UV (microvolt), MV (millivolt), V (volt).
- current: NA (nanoampere), UA (microampere), MA (milliampere), A (ampere).
- time: MS (millisecond), S (second).

By default, voltages are expressed in volts, currents in milliamperes and times in seconds.

#### Mnemonics:

The mnemonics are used to specify a command among several command options. They are composed of a group of one to twelve characters (alphanumeric or <\_>) first of which being alphabetical.

The SN 8310 recognizes:

- the range mnemonics: "**V100**" "**V10**" "**V1**" "**MV100**" "**MA100**" "**MA10**" "**MA1**".
- the configuration mnemonic (WIRE): "**WIRE4**" "**WIRE2**".
- the function mnemonics: "**V**" "**A**".
- various mnemonics: "**PRIM**" "**LIN**" "**ON**" "**OFF**".

The min. and max. number of arguments and type of each of them are specific to each command.

An optional argument can only be specified if the previous one is also specified.

In description of commands below, the optional arguments and suffixes are between [ ].

5.12.2.2 Response messages

Some commands need response from the SN 8310. The headers of these commands end with <?>. These commands are called **queries**.

When a command message contains queries, the SN 8310 prepares a response message which is normally read by the controller before a new message command is emitted.

As a message command may contain several queries, the responses are placed in the response message according to the query order and are separated by <;>.

A response message is ended by <LF + EOI>.

A response can include several **response elements** separated by <,>.

The IEEE-488.2 standard specifies eleven types of response elements. Among them, the SN 8310 responses can include the following ones:

- Mnemonics.
- Decimal whole number with or without sign (NR1).
- Decimal fractional number with **fixed decimal point** (NR2).
- Character string between <">.
- Eight-bit byte arbitrary block of definite length which always starts with #NX..X where:  
 N: non-zero numerical character,  
 X..X: N numerical characters giving, in decimal, the number of eight-bit bytes contained in the response element (#NX..X excluded).
- Arbitrary block of 7-bit ASCII character (except <LF>) always placed at the end of the message.

5.12.2.3 Detection of errors in remote command

The IEEE-488.2 standard specifies four types of errors which depend on their cause and report in the Event Status Register (ESR).

**Command error:**  
 Illegal coding of command (unknown header, illegal coding of arguments, type or number of arguments different from those specified in the command). The current command and next are not executed. The CDE bit of ESR is set to 1.

**Execution error:**  
 The command is correctly coded but cannot be executed because one or several arguments are not compatible or out of the command limits. The next commands are executed. The EXE bit of ESR is set to 1.

**Instrument error:**  
 The command cannot be executed for reasons which depend on the instrument current state. The next commands are executed. The DDE bit of ESR is set to 1.

**Query error:** see exception procedures, § 5.12.2.7.

Each time an error occurs, an error message is stored in a fault queue which can contain up to 16 entries. Above 16, the first ones are discarded.

5.12.2.4 Instrument registers, service request synchronization

The SN 8310 has several registers able to generate a service request through the report and enable actions:

**One condition register:**  
 ISR (Instrument Status Register).

**Two event registers:**  
 ESR (standard Event Status Register).  
 ISCR (Instrument Status Change Register).

**One status register:**  
 STB (Status Byte) which stores the status word of the IEEE-488 interface each time a change occurs.

**Three enable registers:**  
 ESE (standard Event Status Enable).  
 SRE (Service Request Enable).  
 ISE (Instrument Status Change Enable).

**Specification of the register bits:**

**Bits:**

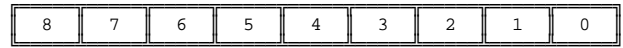

**ISR, ISCR, ISE:**

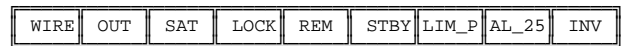

The ISCR bits are set to 1 when the equivalent ISR bit changes state, except the OUT bit which is set to 1 only when the OUT bit of ISR changes from 0 to 1.

When one ISCR bit changes for 1, if the equivalent ISE bit is set to 1, the ISB bit of STB changes for 1.

**OUT:**  
 Changes from 1 to 0, then from 0 to 1 when the value of the output set point changes (except if due to a range changing).

**SAT:**  
 Output amplifier saturated.

**LOCK:**  
**Remote** state locked: the controller only can reset the unit to **Local** state.

**REM:**  
**Remote** state: only the LOC key of the keyboard is active.

**STBY:**  
 Standby: the output value is equal to zero whatever is the set point.

**LIM\_P:**  
 Programmed limit ON.

**AL\_25:**  
 Internal supply of the output amplifier limited to 25V.

**INV:**  
 Polarity is inverted at terminals of the unit.

*N.B: The keyboard or remote commands cause the ISR and ISCR bits to change.*

**ESR, ESE:**

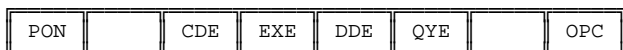

When one ESR bit changes for 1, if the equivalent ESE bit is set to 1, the ESB bit of STB changes for 1.

**PON:**

Changes for 1 at each switching on of the unit or IEEE-488 interface and each time the interface mode has changed (i.e., each time the interface becomes active).

**CDE:**

Command error: unknown header or illegal arguments. The next commands are not executed.

**EXE:**

Execution error: arguments out of limits. The next commands are executed.

**DDE:**

Instrument error: arguments not compatible or out of limits for the present state of the instrument. The next commands are executed.

**QYE:**

Query error: Error in acquisition of a response message.

**OPC:**

Operation complete: changes for 1 after the \*OPC command when all the pending commands are complete.

**STB, SRE, status word:**

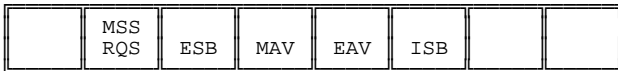

When one bit of the status word (other than RQS) changes for 1 and that the equivalent SRE bit is set to 1, the RQS bit of the status word together with the MSS bit of STB change for 1 and the bus SRQ line becomes active.

When the status word of the IEEE-488 interface is read by the controller during a **Serial Poll**, the interface unasserts the SRQ line and the RQS bit changes for 0, while the MSS bit of STB changes for 0 only when the service request cause has disappeared.

**ESB:**

ESR report.

**MAV:**

Message available: at least one eight-bit byte available in the output buffer.

**EAV:**

Error available: at least one error message available in the fault queue.

**ISB:**

ISCR report.

5.12.2.5 Input buffer

**IEEE-488 mode:**

Each eight-bit byte received by the SN 8310 is stored in a portion of memory called **input buffer**. The input buffer holds up to 128 eight-bit bytes and operates in a **first in, first out** fashion (FIFO).

An attribute, associated with each eight-bit byte of the input buffer, allows storing the state of the EOI line of the IEEE-488 bus and the GET message of the bus as a separate eight-bit byte.

The input buffer is transparent to the user and enables the SN 8310 to receive data faster than it can process them.

When the input buffer is full, the SN 8310 holds off the handshake with the NRD (Not Ready For Data) line. When it has processed an eight-bit byte from the full input buffer, it then completes the handshake, allowing the controller to send another eight-bit byte.

The input buffer is cleared at switching on and on receiving the DCL (Device Clear) or SDC (Selected Device Clear) messages from the IEEE-488 bus.

**RS 232 mode:**

Same as above, except that:

- When programming the XON/XOFF protocol, the SN 8310 issues a Control/S (XOFF, 13 in hexadecimal or 19 in decimal) when the input buffer becomes 75 % full (96 eight-bit bytes).

Then, the SN 8310 issues a Control/Q (XON, 11 in hexadecimal or 17 in decimal) when the input buffer is less than 25 % (32 eight-bit bytes).

When programming the DTR/CTS protocol, the CTS line of the serial interface is raised to a negative or positive potential in the same conditions as for the XON/XOFF protocol (XON = +; XOFF = -).

If the controller disregards the protocol and that the input buffer capacity is exceeded, the SN 8310 stops storage of data and an error occurs.

- The characters Control/D (04 in hexadecimal or 4 in decimal) and Control/T (14 in hexadecimal or 20 in decimal) have the same effect as the DCL and SDC messages of the IEEE-488 bus.

5.12.2.6 Output buffer

**IEEE-488 mode:**

Responses to queries are stored in a portion of memory called **output buffer** until they are read by the controller. The output buffer holds up to 128 eight-bit bytes.

As soon as the SN 8310 is addressed to talk by the controller, the content of the output buffer is sent on the IEEE-488 bus, together with the <LF + EOI> terminator when the whole response message has been read by the controller.

**RS 232 mode:**

Same as above, except that:

- Whatever is the protocol programmed, the DTR line must be raised to a positive potential, allowing the serial interface to emit characters.

- The interface starts emission of the response only when the output buffer is full or the command message terminator has been read.

- if the XON/XOFF protocol is programmed, the interface stops emission on receiving a Control/S (XOFF) and restarts emission on receiving a Control/Q (XON).

5.12.2.7 Exception procedures

Exception procedures are provided when the controller does not meet the IEEE-488.2 standard.

**INTERRUPTED:**

The controller must read the response message before it attempts to send another command message. If not, the QYE bit of ESR is set to 1, the output buffer is cleared and the INTERRUPTED error message is placed in the fault queue.



**UNTERMINATED:**

The controller must send a command message containing queries before it attempts to read a response message. If not, the QYE bit of ESR is set to 1, the output buffer is cleared and the UNTERMINATED error message is placed in the fault queue.

**DEADLOCKED:**

When the output buffer is full, a command message containing queries must not lead the SN 8310 to store additional characters before it has read the end of the message. In that case, the QYE bit of ESR is set to 1, the output buffer is cleared, the DEADLOCKED error message is placed in the fault queue and the rest of the message is executed.

**TRUNCATED RESPONSE:**

A query of which the response must be placed at the end of the message (arbitrary block of characters) must not be followed by another query in a same command message. If not, the QYE bit of ESR is set to 1, the TRUNCATED RESPONSE error message is placed in the fault queue and the responses to the queries following are cleared from the response message.

5.12.2.8 Sequential and overlapped commands, commands ignored in LOCAL

Commands executed immediately as they are encountered are called sequential commands.

Commands that begin execution, but are completed some time later are called overlapped commands.

Most of the SN 8310 commands are sequential.

All the commands which change the instrument output or the values stored in saved memory are ignored when the SN 8310 is set to local state. The DDE bit of ESR is set to 1 and the LOCAL error message is placed in the fault queue.

**5.12.3 SN 8310 remote commands**

5.12.3.1 Commands meeting the IEEE-488.2 standard (IEEE or RS 232 mode)

**\*CLS** (sequential command)

Clears the ESR and ISCR.  
Argument: none.

**\*ESE VAL** (sequential command)

Programs the Event Status Enable register.  
Argument: VAL which is a decimal number between 0 and 255.

**\*ESE?** (sequential command)

Returns the value from the Event Status Enable register.  
Argument: none.  
Response: decimal whole number between 0 and 255.

**\*ESR?** (sequential command)

Returns the value from the Event Status Register and clears the register.  
Argument: none.  
Response: decimal whole number between 0 and 255.

**\*SRE VAL** (sequential command)

Programs the Service Request Enable register.  
Argument: VAL which is a decimal number between 0 and 255.

**\*SRE?** (sequential command)

Returns the value from the Service Request Enable register.  
Argument: none.  
Response: decimal whole number between 0 and 255.

**\*STB?** (sequential command)

Returns the value from the STatus Byte register. Does not reset the MSS bit to zero and asserts the SRQ line on the IEEE-488 bus.  
Argument: none.  
Response: decimal whole number between 0 and 255.

**\*IDN?** (sequential command)

Returns the instrument identification.  
Argument: none.  
Response: arbitrary block of characters with four fields separated by <,>.

- 1 AOIP\_MESURES
- 2 SN 8310
- 3 Sxxxxxx (Serial number)
- 4 X.xx (Software edition)

**\*OPC** (sequential command)

Sets the OPC bit of the ESR register to 1 when all the pending operations are complete.  
Argument: none.

**\*OPC?** (sequential command)

Returns a 1 when all the pending operations are complete.  
Argument: none.  
Response: decimal whole number "1"

**\*WAI** (sequential command)

Forces the unit to wait until all the pending operations are complete.  
Argument: none.

**\*TRG** (sequential command)

Though the IEEE-488 interface provides the DT0 function, this command is recognized but has no effect (idem for the GET message of the bus).  
Argument: none.

**\*RST** (sequential command)

Forces all the pending commands to complete in the shortest possible time. If the **step** or **synthesizer** functions are running, they are interrupted.  
Sets the unit to the switching on state:  
- 10 V range  
- output set point: 00.00000 V  
- operation  
Does not affect any other state of the unit.  
Argument: none.

**\*TST?** (sequential command)

Checks the correct operation of the link between the analog and logic boards of the SN 8310 and validity of the calibration factors.  
Argument: none.  
Response: decimal whole number as stated in table below.

0	Correct
1	Faulty link.
2, 4 or 8	Illegal primary factors.

102 or 104	Illegal secondary factors, 100 V range.
202 or 204	Illegal secondary factors, 10 V range.
302 or 304	Illegal secondary factors, 1 V range.
402 or 404	Illegal secondary factors, 100 mV range.
502 or 504	Illegal secondary factors, 100 mA range.
602 or 604	Illegal secondary factors, 10 mA range.
702 or 704	Illegal secondary factors, 1 mA range.

**\*PSC FLAG** (sequential command)

Controls the automatic resetting to zero of the ESE and SRE registers at switching on.  
Argument: Decimal number between - 32767 and 32767.  
If FLAG = 0: ESE and SRE keep the value they have before the previous switching off of the unit, thus enabling a service request at switching on.  
If not, ESE and SRE are reset to zero at switching on and there is no service request capability before programming of ESE and SRE.

Example: \*PSC 0;\*ESE 128;\*SRE 32 enables a service request each time the unit is switched on.

**\*PSC?** (sequential command)

Returns the flag state from the ESE and SRE automatic resetting to zero.  
Argument: none.  
Response: decimal whole number 0 = no resetting to zero.  
1 = resetting to zero.

5.12.3.2 Commands specific to the RS 232 MODE

**REM** (sequential command)

Sets the instrument to remote state. Same as the REN message of IEEE-488 bus.  
Argument: none.

**LOC** (sequential command)

Sets the instrument to local state. Same as the GTL message of the IEEE-488 bus.  
Argument: none.

**LLO** (sequential command)

Prohibits return to local state by the LOC key. Same as the LLO message of the IEEE-488 bus.  
Argument: none.

5.12.3.3 Commands specific to the SN 8310 registers

**ISE VAL** (sequential command)

Programs the Instrument State Enable register.  
Argument: VAL which is a decimal number between 0 and 255.

**ISE?** (sequential command)

Returns the value from the ISE register.  
Argument: none.  
Response: decimal whole number between 0 and 255.

**ISR?** (sequential command)

Returns but does not clear the value from the Instrument Status Register.  
Argument: none.  
Response: decimal whole number between 0 and 255.

**ISCR?** (sequential command)

Returns and clears the value from the Instrument Status Change Register.  
Argument: none.  
Response: decimal whole number between 0 and 255.

5.12.3.4 Commands acting or informing on the SN 8310 output

**OPER** (sequential command ignored in local)

Forces the SN 8310 to output the present set point.  
Argument: none.

**STBY** (sequential command ignored in local)

Forces the SN 8310 to be equal to 0 whatever is the set point.  
Argument: none.

**DIRECT** (sequential command ignored in local)

Forces the direct polarity on the output terminals of the SN 8310.  
Argument: none.

**REVERSE** (sequential command ignored in local)

Forces the reverse polarity on the output terminals of the SN 8310.  
Argument: none.

**RANGE RAN, [WIRE]** (sequential command ignored in local)

Sets the SN 8310 to the specified range and the set point to 0.

Arguments:

**RAN** which is the range mnemonic.

**WIRE** which is the optional output configuration mnemonic.

**OUT VAL [SUF], [RAN], [WIRE]** (sequential command ignored in local)

Specifies an output set point value and optionally a range.

Arguments:

**VAL** which is a decimal number with optional suffix (UV, MV, V, NA, UA, MA or A). The suffix must be compatible with the present or specified range. By default, VAL is expressed in volts or in milliamperes.

**RAN** which is the optional range mnemonic.

If the specified range is different from the present one, the RAN argument forces the range to change (i.e., setting the set point to 0) before the set point takes the VALue. If the present range is the same as the specified one, RAN has no effect.

**WIRE** which is the optional output configuration mnemonic.

The specified value must be within the present or specified range limits. If the internal supply of the output amplifier is limited to 25 V, it must be lower than 25 V. If the programmed limit is on, it must be lower than the programmed one in absolute value.

**Note:** This command does not allow the user to switch from a current range to a voltage range or vice-versa. For that, use command **RANGE RAN, [WIRE]**.

**RANGE?** (sequential command)

Returns the present range.  
Argument: none.  
Response: present range mnemonic and present output configuration mnemonic.

**OUT?** (sequential command)

Returns the value of the output set point and unit.  
Argument: none.  
Response: two fields separated by <,> according to table below.

1: value	Decimal number.
2: unit	Mnemonic.

The value is formatted as the instrument display, the number of figures after the decimal point depends on the present range.

Examples:

```
057.2351,V      100 V range
-04.1283,V      100 V range
1.018123,V      1 V range
-.091234,V      1 V range
```

**MODE?** (sequential command)

Returns the SN 8310 operating specifications.  
Argument: none.  
Response: nine fields separated by <,> according to table below.

1: output set point	Decimal number.
2: unit	Mnemonic.
3: present range	Mnemonic.
4: output configuration	WIRE4/WIRE2 mnemonic.
5: output state	OPER/STBY mnemonic.
6: terminal polarity	DIR/INV mnemonic.
7: internal supply limit	L25_ON/L25_OFF mnemonic
8: programmed limit	Decimal number.
9: unit	Mnemonic
10: programmed limit enabling	ON/OFF mnemonic.

The value of the output set point and programmed limit are formatted according to the present range. If the programmed limit is higher than the present range limit, the value returned is <999.9999>.

**INCR VAL [SUF] , [RAN]** (sequential command ignored in local)

Increases VALue at the output set point and optionally specifies a range.

Arguments:

**VAL** which is a decimal number with optional suffix (UV, MV, V, NA, UA, MA or A). The suffix must be compatible with the present or specified range. By default, VAL is expressed in volts or milliamperes.

**RAN** which is the optional range mnemonic. If the specified range is different from the present one, the RAN argument forces the range to change (i.e., setting the set point to 0) before VAL is increased to the set point. If the present range is the same as the specified one, RAN has no effect.

After increasing, the set point value must remain within the present or specified range limits. If the internal supply of the output amplifier is limited to 25 V, it must remain lower than 25 V. If the programmed limit is on, it must remain lower than the programmed one in absolute value.

**5.12.3.5 Commands linked to parameters stored in saved memory (other than the output set points stored)**

**L\_25V ENABLE** (sequential command ignored in local)

Enables or disables the 25 V limit of the internal supply of the output amplifier.  
Argument: ENABLE which is the ON or OFF mnemonic.

**L\_25V?** (sequential command)

Returns the 25 V limit state from the internal supply of the output amplifier.  
Argument: none.  
Response: ON or OFF mnemonic.

**LIMIT ENABLE** (sequential command ignored in local)

Enables or disables the programmed limit.  
Argument: ENABLE which is the ON or OFF mnemonic.

If value of the output set point is higher than the programmed limit, it is automatically limited by ENABLE = ON.

**LIMIT? [RAN]** (sequential command)

Returns the value and state from the programmed limit in voltage or current depending on the present or specified range.  
Argument: RAN which is the optional range or function mnemonic.  
Response: three fields separated by <,> according to table below.

1: value	Decimal number.
2: unit	Mnemonic.
3: state	ON or OFF mnemonic.

The value of the programmed limit is formatted according to the present or specified range. If the programmed limit is higher than the present or specified range, the value returned is <999.9999>.  
If RAN = "V" or "A", the response is formatted to give the maximum of significant figures.

**STOLIM LIM [SUF] , [RAN]** (sequential command ignored in local)

Programs either the voltage limit or the current limit according to the present or specified range.

Arguments:

**LIM** which is a decimal number with optional suffix (UV, MV, V, NA, UA, MA or A). The suffix must be compatible with the present or specified range. By default, LIM is expressed in volts or in milliamperes.  $0.0 \leq LIM \leq 110.0$ .

**RAN** which is the optional range or function mnemonic.

**INCRP VAL, [RAN]** (overlapped command ignored in local)

Depending on VAL sign, increases or decreases the output set point from the value programmed a number of times equal to the number programmed and according to the interval programmed.  
If required, specifies a range.

Arguments:

**VAL** which is a decimal number without suffix.

**RAN** which is the optional range mnemonic. If the specified range is different from the present one, the RAN argument forces the range to change (i.e., setting the set point to 0) before the step cycle starts. If the present range is the same as the specified one, RAN has no effect.

The set point value must remain within the present or specified range limits. If the internal supply of the output amplifier is limited to 25 V, it must remain lower than 25 V. If the programmed limit is on, it must remain lower than the programmed one in absolute value. If one of these limits is exceeded, the steps stop.

#### **STOINCRP STEP [SUF] , [INTERVAL [SUF] ] , [NB] , [AUTO] , [ENABLE]**

(sequential command ignored in local)

Programs the step parameters.

Arguments:

**STEP** which is a decimal number with optional suffix (UV, MV, V, NA, UA, MA or A). By default, STEP is expressed in volts or in milliamperes.  
 $0.0 \leq \text{STEP} \leq 110.0$ .

**INTERVAL** which is a decimal number with optional suffix (MS or S).  
 $0.1 \leq \text{INTERVAL} \leq 500.0$ .

**NB** which is a decimal number without suffix.  
 $1 \leq \text{NB} \leq 1\ 210\ 000$ .

**AUTO** which is the ON or OFF optional mnemonic.

**ENABLE** which is the ON or OFF optional mnemonic.

*N.B:*

*INCRP and STOINCRP commands are slightly different from those executed on the keyboard:*

*- When using the keyboard, the increment value is read in volts, millivolts or milliamperes depending on the present range, while remotely it is read in volts or in milliamperes.*

*- AUTO and ENABLE are only keyboard commands and the INCRP command always read their ON state.*

*- INCRP is an overlapped command and before it is completed, other commands (except INCRP and SYNTHE) can be sent to the SN 8310 and immediately executed including those acting on the output. But the STOINCRP command has no effect on the pending steps.*

#### 5.12.3.6 Commands linked to the output set points stored

#### **STORE NO, [VAL [SUF] ] , [RAN]**

(sequential command ignored in local)

Stores an output set point value.

Arguments:

**NO** which is a decimal number without suffix (memory number).  
 $0 \leq \text{NO} \leq 99$ .

**VAL** is an optional decimal number with optional suffix (UV, MV, V, NA, UA, MA or A). The suffix must be compatible with the present or specified range. By default, VAL is expressed in volts or in milliamperes. VAL must be within the present or specified range limits.

**RAN** is the optional range or function mnemonic.

There are 100 memories for the current set points and 100 memories for the voltage set points. The present or specified range recognizes the memory type.

The specified value is stored to the NO address. NO specified only, will store the value of the present output set point.

#### **RECALL NO, [RAN]** (sequential command ignored in local)

Gives, to the output set point, the value stored to the address NO and, if required, changes the range.

Arguments:

**NO** which is a decimal number without suffix.  
 $0 \leq \text{NO} \leq 99$ .

**RAN** which is the optional range mnemonic.

The stored value must be within the present or specified range limits. If the internal supply of the output amplifier is limited to 25 V, it must be lower than 25 V. If the programmed limit is on, it must be lower than the programmed one in absolute value. If one of these limits is reached, the set point does not change.

#### **MEM? NO1, [NO2] , [RAN]** (sequential command)

Returns the values stored between the NO1 and NO2 addresses.

Arguments:

**NO1** which is a decimal number without suffix.

**NO2** which is a decimal number without suffix.  
 $0 \leq \text{NO1} \leq \text{NO2} \leq 99$ .

**RAN** which is the optional range or function mnemonic.

Response: eight-bit byte block of definite length.

For example, response to the "MEM? 2,5,V10" command will be:

```
#40061<CR><LF>
02:01.23456 V<CR><LF>
03:00.31234 V<CR><LF>
04:02.48932 V<CR><LF>
05:10.12345 V<CR>
```

<CR> and <LF> are ASCII characters having the hexadecimal 0D and 0A codes (13 and 10 in decimal). The stored values are formatted according to the present or specified range. If a value is not within the range limits, it will be returned as <999.9999> or <-99.9999>.

If RAN = "V" or "A", the response is formatted to give the maximum of significant figures.

When there is no **command error** and **execution error** detected, the MEM? query always has a response:

- If  $\text{NO2} < \text{NO1}$  or  $\text{NO2} < 0$  or  $\text{NO2} > 99$ , then  $\text{NO2} = \text{NO1}$ .

- If  $\text{NO1} < 0$  or  $\text{NO1} > 99$ , then  $\text{NO1} = 0$ .

- If RAN is not a range mnemonic, then RAN = present range.

### SYNTHE? (sequential command)

Returns the specifications from the **Synthesizer** function.

Argument: none.

Response: five fields separated by <, > according to table below.

1: decimal whole number	First memory number recalled.
2: decimal whole number	Last memory number recalled.
3: decimal number	Interval in seconds.
4: mnemonic	<S> (second).
5: decimal whole number	Number of cycles.

### STOSYNTHE NO1,NO2, [INTERVAL [SUF] ] , [NB] , [AUTO]

Programs the specifications of the **synthesizer** function.

Arguments:

**NO1** which is a decimal number without suffix indicating the first memory number.

**NO2** which is a decimal number without suffix indicating the last memory number.  
0 ≤ NO1 ≤ NO2 ≤ 99.

**INTERVAL** which is an optional decimal number with optional suffix (MS or S).  
0.1 ≤ INTERVAL ≤ 500.0.

**NB** which is an optional decimal number without suffix.  
1 ≤ NB ≤ 65000.

**AUTO** which is the ON or OFF mnemonic.

In keyboard command, AUTO indicates how the stored set points are swept (automatic or manual).

### SYNTHE ACT, [RAN] (overlapped command ignored in local)

Activates or stops the **synthesizer** function. If required, changes the range.

Arguments:

**ACT** which is the ON or OFF mnemonic.  
- If ACT = ON, the set point successively takes the values of the set points stored from the first memory number programmed up to the last memory number programmed and according to the interval programmed. The cycle runs again depending on the number programmed.  
If ACT = OFF, the **synthesizer** function stops.

**RAN** which is the range mnemonic.  
- If the specified range is different from the present one and that ACT = ON, RAN forces the range to change (i.e., setting the set point to 0) before the **synthesizer** is activated.  
- If the present range is the same as the specified range, RAN has no effect.

SYNTHE is an **overlapped** command and before it is completed, other commands (except SYNTHE and INCRP) can be sent to the SN 8310 and immediately executed including those acting on the output. But the STOSYNTHE command has no effect on the pending cycles.

### 5.12.3.7 Commands related to the errors

The last 16 errors detected during reading or execution of commands are stored in a fault queue.

The EAV bit of STB is set to 1 as long as there is at least one error message in the fault queue.

#### CL\_ERR (sequential command)

Clears all the error messages and resets the EAV bit to 0.  
Argument: none.

#### ERR\_NO? (sequential command)

Returns the most recent error number and clears the message from the queue. If there is no more error message available in the queue, the EAV bit is set to 0.  
Argument: none.  
Response: decimal whole number, 0 if no error.

#### ERR? [NO] (sequential command)

Returns the message corresponding to the most recent error or to NO.

Argument:

**NO** optional decimal number without suffix.  
0 ≤ NO ≤ 21.

Response: Character strings between < >.

- If NO unspecified, the ERR? command operates like ERR\_NO? regarding the fault queue.

- If NO specified, the fault queue does not change.

### 5.12.3.8 Commands for calibration of the SN 8310

The calibration principle is explained in § 7.8.

Calibration commands from the IEEE bus are as follows:

#### CAL\_OUT VAL [SUF] ,RAN (sequential command ignored in local)

Specifies an output set point value and sets off either all the corrections, or only the secondary corrections.  
Forces a range changing.  
Disables for a moment the limit on the internal supply of the output amplifier together with the programmed limit.

Arguments:

**VAL** (set point value) which is a decimal number with optional suffix (UV, MV, V, NA, UA, MA or A). The suffix must be compatible with the specified range. By default, VAL is expressed in volts or in milliamperes.  
VAL must be within the specified range limits.

**RAN** which is the range mnemonic (except MV100 and MV10) or PRIM.

If RAN = PRIM the range switches to 10 volts and all the corrections are cleared. If not, only the secondary corrections are cleared.

**CAL\_EXEC? VAL1 [SUF] , MEA1 [SUF] ,VAL2 [SUF] , MEA2 [SUF] ,RAN , [DATE]**

or

**CAL\_EXEC? VAL1 [SUF] ,VAL2 [SUF] ,VAL3 [SUF] , MEA3 [SUF] ,RAN, [DATE]**

(sequential commands ignored in local)

Executes the specified calibration and returns an execution report.

Arguments:

<b>VAL1</b>	Decimal numbers with optional suffix (UV, MV, V, NA, UA, MA or A). The suffix must be compatible with the specified range
<b>VAL2</b>	
<b>VAL3</b>	
<b>MEA1</b>	By default, VAL1, VAL2, VAL3, MEA1, MEA2 and MEA3 are expressed in volts or in milliamperes.
<b>MEA2</b>	
<b>MEA3</b>	

**RAN** which is the range mnemonic (except MV100 and MV10) or PRIM or LIN.

**DATE** (calibration date) which is an optional decimal number. Date is in the form of "yy.ww". (year and week).

Response: two mnemonics separated by <, > according to table below.

1: Recalling the RAN argument.
2: Execution report PASS or ERR ...

When there is no **command error** and **execution error** detected, the CAL\_EXEC? query always has a response:

- If CAL = PRIM, the specified range is the 10 V range.
- If RAN is a range mnemonic or PRIM, the command performs a primary or secondary calibration in two points. The numerical arguments are VAL1, MEA1, VAL2 and MEA2. VAL1 and VAL2 are the values given in two consecutive commands "CAL\_OUT VAL,CAL", MEA1 and MEA2 being the corresponding output values measured. RAN must be same for the three commands ("CAL\_OUT ...,CAL", "CAL\_OUT ...,CAL" and "CAL\_EXEC? ...,CAL").
- If CAL = LIN, the specified range is the 10 V range and the command computes the linearity correcting factor. The numerical arguments are VAL1, VAL2, VAL3, MEA3. VAL1 and VAL2 are the two set points of the primary calibration previously performed in two points, VAL3 is the value given in "CAL\_OUT VAL,V10" command and MEA3 is the output value measured.

**Primary calibration example:**

```
Send command      "CAL_OUT 0,PRIM"
Measure output value 0,000215 V as an example
Send command      "CAL_OUT 10,PRIM"
Measure output value 10,000500 V as an example
Send command      "CAL_EXEC? 0,215UV,10,10,0005,PRIM"
Response          "PRIM,PASS"

Send command      "CAL_OUT 5,V10"
Measure output value 5,000050 V as an example
Send command      "CAL_EXEC? 0,10,5,5,00005,LIN,90,13"
Response          "LIN,PASS"
```

**Secondary calibration example:**

```
Send command      "CAL_OUT 0,V100"
Measure output value 0,00192 V as an example
Send command      "CAL_OUT 100,V100"
Measure output value 100,01200 V as an example
Send command      "CAL_EXEC? 0,1,92MV,100,100,012,V100"
Response          "V100,PASS"
```

**CAL\_RESTOR**

After a CAL\_OUT command, restores either the primary or the primary and secondary corrections together with the programmed limit state and that of the internal supply of the output amplifier.

Argument: none.

The CAL\_EXEC? command, if successful, restores the corrections with the new calibration correcting factors. If not, to restore the corrections after a CAL\_OUT, call CAL\_RESTOR, or switch the unit off then on.

**CAL\_RPT?**

Returns the calibration factors and report.  
Argument: none.  
Response: eight-bit byte block of definite length.

Example:

```
#40250<CR><LF>
AOIP_MESURES SN8310 S011001<CR><LF>
DATE:90/13<CR><LF>
PRIM :-.0002150,0.9999715,0.0000020<CR><LF>
V100 :-.0019200,0.9998992<CR><LF>
V10 :0.0000000,1.0000000<CR><LF>
V1 :0.0002020,0.9998980<CR><LF>
MA100:-.0021400,0.9993119<CR><LF>
MA10 :0.0000000,1.0000000<CR><LF>
MA1 :0.0000000,1.0000000<CR><LF>
002:004<CR>
```

<CR> and <LF> are ASCII characters having the hexadecimal 0D and 0A codes (13 and 10 in decimal).

## 6. PROGRAMMING

The programming function is used to enter and store data and parameters in nonvolatile memory, concerning:

- **The general processing**, i.e.:
  - . language of the displayed messages,
  - . instrument identity (not programmable).
- **The limits of the emitted signal**, i.e.:
  - . limit values in voltage or current mode,
  - . 25 V limit for the internal voltage source (safety).
- **The evolution of the emitted signal**, i.e.:
  - . step value in automatic emission of consecutive steps,
  - . memory recall for a determined evolution (synthesizer).
- **The interface**, i.e.:
  - . RS 232 link,
  - . IEEE-488 bus.
- **The calibration reserved to maintenance**, i.e.:
  - . calibration parameters,
  - . date of the last calibration.

### 6.1 USING THE KEYBOARD FOR PROGRAMMING

The following keys are used during programming procedures:

-  **PROG** To enter in the programs (two consecutive pressings of the blue key).
- **. 0 to 9** To enter numerical data.
- CL** To delete an incorrect number before entering the correct one.
- ENT** To enter numerical data.  
Affirmative answer to a displayed prompt.
- ↓ et ↑ Negative answer to a displayed prompt and scrolling through the various menu options.

All the other keys are inactive in programming mode, except those used to access a given program.

### 6.2 ACCESSING THE FUNCTION AND CHOOSING THE PROGRAM

The main menu, composed of 9 programs, is available at any time in two different manners:

#### 6.2.1 Direct access to the required program

- Press  Symbol **S** appears.
  - Press **PROG** **PROGRAM ?** message appears for a few seconds.
- The unit requests selection of a program in the main menu.
- Select the required program by pressing the appropriate access key as indicated in table below.

Required program	Programmable information	Access key
<b>LANGUAGE ?</b>	Languages available: French, English, German.	<b>CL</b>
<b>IDENTITY ?</b>	Display of the instrument serial number and software edition.	<b>PROG</b>
<b>MAX.VALUE ?</b>	Selection of the max. value to be emitted in both operating modes.	<b>0</b>
<b>LIM.25 V ?</b>	Max. voltage of the internal supply limited to 25 V or not.	<b>1</b>

Required program	Programmable information	Access key
<b>STEPS ?</b>	Step value. Time interval between two consecutive steps. Number of consecutive steps.	↑ or ↓
<b>SYNTHE. ?</b>	Number of the first memory. Number of the last memory. Time interval between two memory recalls. Number of cycles.	<b>RM</b>
<b>INTERFACE ?</b>	RS 232: - transmission rate, - binary "word" format, - stop bit, - parity check, - protocol. IEEE-488: - address.	<b>LOC</b>
<b>CALIBRATE ?</b>	Calibration factors entered at factory.	<b>2</b>
 <b>This program should only be used for maintenance. Any other uses may alter the performances of the unit.</b>		
<b>CAL. DATE ?</b>	Display of the last calibration date in the form of: YY:WW.	<b>ENT</b>

Do press **ENT** to confirm the choice.

#### 6.2.2 Access to the required program by rotational selection of main menu

Press:

-  **PROG** then ↓ or ↑

The main menu runs on a rotational selection and offers successively the following programs:

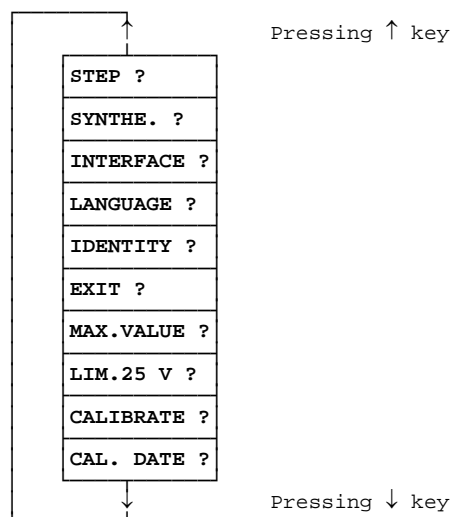

Press **ENT** to confirm the choice.

The **EXIT ?** prompt, to be confirmed with **ENT**, returns the unit to the initial state.

### 6.3 GENERAL PROCEDURE

Each program is made up of a succession of menus selected by means of the ↑ or ↓ key as explained above for the main menu.

They also require numerical data.

The following typographic mode has been used for the diagrams of the various programs explained in pages following:

Initial state is the instrument state before entering in the programming function.

XXXXXXXX ?
------------

 is the display of a prompt to be confirmed.

XX = XXX
----------

 is the display of a numerical data stored into memory to be changed.

↑  

XXXXXXXX ?
XXXXXXXX ?

 shows a menu where the first prompt displayed is always the same. Selection of another prompt is made by pressing ↑ or ↓ key.

↓  
 ↑  

XXXXXXXX ?
XXXXXXXX ?
XXXXXXXX ?

 shows a menu where the first prompt displayed is the one stored into memory. Selection of another prompt is made by pressing ↑ or ↓ key.

↓  
**ENT** means pressing **ENT** key to confirm a prompt or numerical data (changed or not).

### 6.4 GENERAL PROCESSING PROGRAMS

#### 6.4.1 Language

See key in § 6.3.

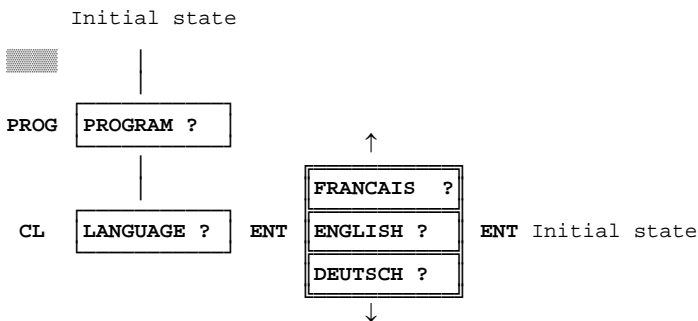

When the **LANGUAGE ?** program is confirmed with **ENT**, the display indicates the current language.

#### 6.4.2 Instrument identity

See key in § 6.3.

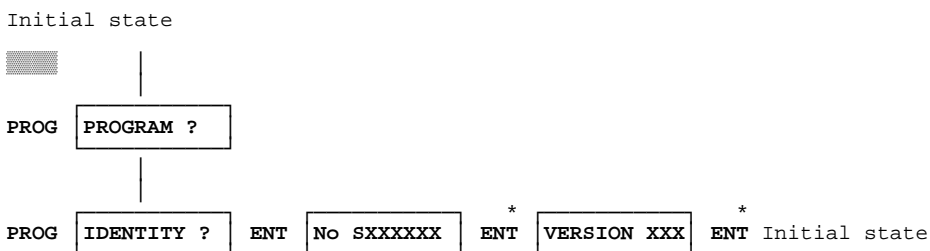

\* Pressing **ENT** key is optional because the unit displays its serial number, software edition and then returns to initial state successively.



## 6.5 LIMIT PROGRAMS

### 6.5.1 Max. emitted value

See key in § 6.3.

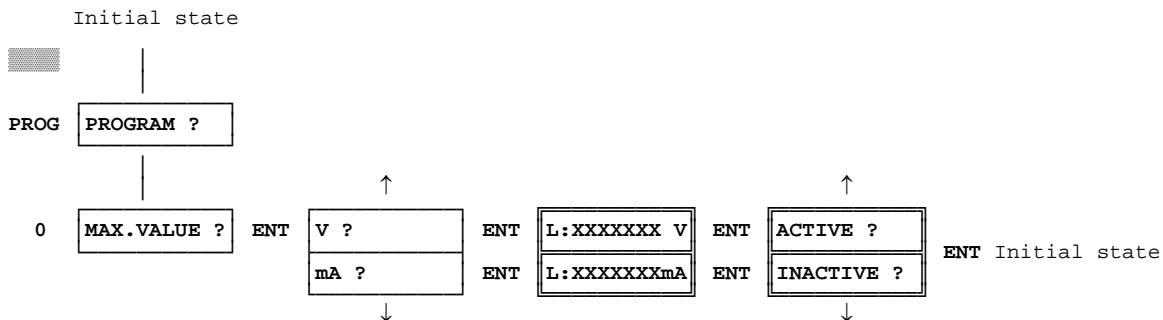

### MEANING OF THE DISPLAYED MESSAGES

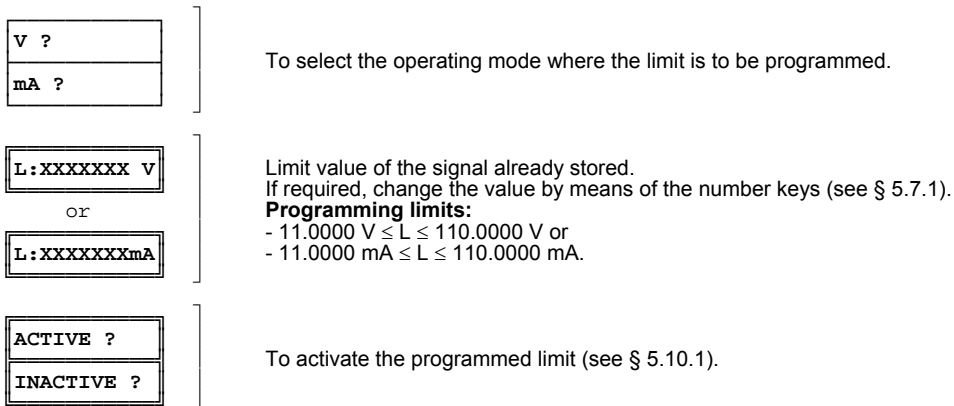

### 6.5.2 Max. voltage delivered by the internal supply

See key in § 6.3.

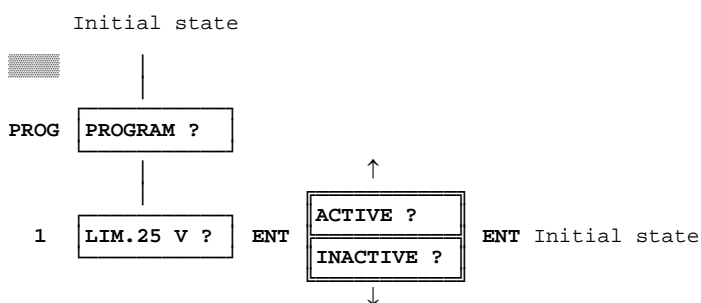

### MEANING OF THE DISPLAYED MESSAGES

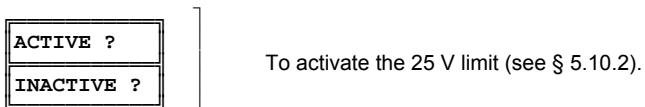

## 6.6 SIGNAL EVOLUTION PROGRAMS

### 6.6.1 Steps

See key in § 6.3.

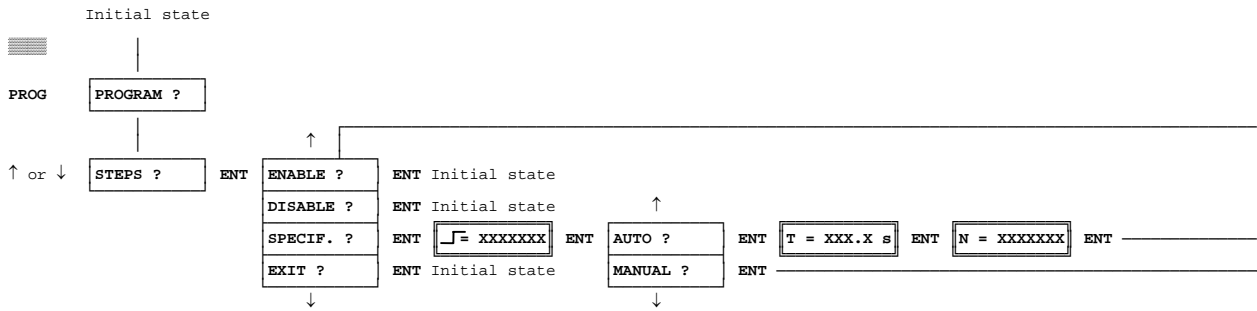

### MEANING OF THE DISPLAYED MESSAGES

ENABLE ?
DISABLE ?
SPECIF. ?
EXIT ?

To enable the step function (see § 5.7.4).  
The □ symbol appears at left of the display when enabling the function.

To enter or display the step parameters.

Another way to exit from the program instead from **ENABLE ?** or **DISABLE ?** prompt.

□ = XXXXXXXX
--------------

Step value.  
If required, change it by means of the number keys (see § 5.7.1).  
**Programming limits:**  $0 \leq \square \leq 11\,000\,000$  RU expressed in V, mV or mA.

**N.B:** Display of □=\*XXXXXX indicates that recall of a step value stored in memory is not compatible with the selected range.

AUTO ?
MANUAL ?

To select either automatic or manual generation (see § 5.7.4.1 and 5.7.4.2).

T = XXX.X s
-------------

Time interval between two consecutive steps in automatic mode.  
If required, change it by means of the number keys (see § 5.7.1).  
**Programming limits:**  $0.1 \text{ s} \leq T \leq 500.0 \text{ s}$ .

N = XXXXXXXX
--------------

Number of step repetition cycles in automatic mode.  
If required, change it by means of the number keys (see § 5.7.1).  
**Programming limits:**  $1 \leq N \leq 1\,210\,000$ .

## 6.6.2 Synthesizer

See key in § 6.3.

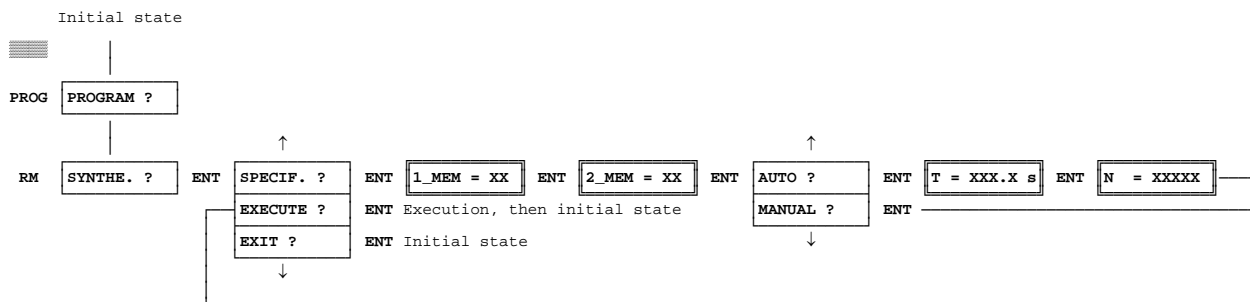

### MEANING OF THE DISPLAYED MESSAGES

SPECIF ?
EXECUTE ?
EXIT ?

To enter or display the synthesizer parameters.

To start execution of the memory recall according to the programmed parameters (see § 5.11.3).

To exit from and unexecute the program.

1_MEM = XX
------------

First memory recalled.  
If required, change the number by means of the number keys (see § 5.7.1).  
**Programming limits:**  $00 \leq 1\_MEM \leq 99$

2_MEM = XX
------------

Last memory recalled.

AUTO ?
MANUAL ?

To recall memories either in automatic or in manual mode (see § 5.11.3.1 and 5.11.3.2).

T = XXX.X s
-------------

Time interval between two consecutive memory recalls in automatic mode.  
If required, change it by means of the number keys (see § 5.7.1).  
**Programming limits:**  $0.1 \text{ s} \leq T \leq 500.0 \text{ s}$ .

N = XXXXX
-----------

Number of cycles to be executed in automatic mode.  
If required, change it by means of the number keys (see § 5.7.1).  
**Programming limits:**  $1 \leq N \leq 65\,000$ . The program is not executed with  $N = 0$ .

## 6.7 INTERFACE

See key in § 6.3.

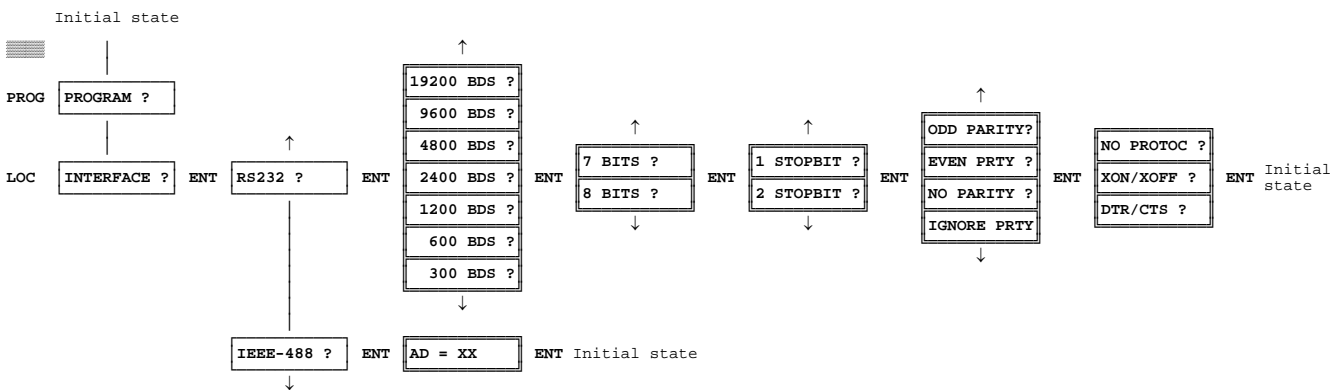

### MEANING OF THE DISPLAYED MESSAGES

RS232 ?
IEEE-488 ?

To select the interface mode for the models equipped with the optional IEEE interface.

19200 BDS ?
9600 BDS ?
4800 BDS ?
2400 BDS ?
1200 BDS ?
600 BDS ?
300 BDS ?

To select the transmission rate.  
The displayed rate is the one stored into memory.  
The selected rate must be compatible with the computer used.

7 BITS ?
8 BITS ?

To select the binary information either in "words" of 7 bits or 8 bits.

1 STOPBIT ?
2 STOPBIT ?

To select the number of stop bits.

ODD PARITY?
EVEN PRTY ?
NO PARITY ?
IGNORE PRTY

To select the information concerning the parity check.

NO PROTOC ?
XON/XOFF ?
DTR/CTS ?

To select the information concerning the buffer of the receiver

XON/XOFF ? : Stops transmission when buffer is full and restarts transmission when empty.

DTR/CTS ? : Same as XON/XOFF but using the wires of the RS 232 link.

AD = XX
---------

Instrument address on the IEEE-488 bus.  
If required, change it by means of the number keys (see § 5.7.1).  
**Programming limits:**  $00 \leq AD \leq 30$ .

## 7. MAINTENANCE

In view of the necessary precautions and the risks involved, any maintenance operations, apart from those relating battery charging, should be left to qualified personnel.

### 7.1 OPENING THE UPPER AND LOWER CASINGS

- Switch the unit off, remove the power cord and disconnect the unit from any electrical connection.

- Using a screwdriver, untighten the four screws of the desired casing. Each casing is provided with two short screws at back and two long screws on sides.
- Lift the casing and pull it towards the back.

The upper casing gives access to:

- . the logic board CA 40950 equipped with the optional 12 V battery and charger board CA 40959 if ordered,
- . the optional IEEE-488 board CA 40955.

The lower casing gives access to:

- . the analog board CA 41024.

### 7.2 SETTING THE CASINGS BACK

- Align the two tabs on cover into the slots on the case, pushing the cover into position.
- Insert the 4 screws into the cover to complete replacement onto case.

**WARNING: The two short screws should be mounted at back of the unit and the two long on sides.**

### 7.3 CHANGING THE FUSE

The unit is protected by a 5 x 20 time-lag fuse 160 mA/250 V, meeting the NF C 60-430 standard (sheet III).

When the unit is connected to the power supply and that the indicator "~" remains off, replace the fuse. For that:

- Switch the unit off, remove the power cord and disconnect the unit from any electrical connection.

- Open the upper casing as stated in § 7.1. The fuse is located on the logic board according to diagram below.



- Remove the protection cover of the fuse.
- Insert blade of a small screwdriver between the fuse and support and press gently upwards to remove it.
- Check that fuse is open.
- Replace with same type, AOIP ref.: ER 48124-161.
- Replace the protection cover.
- Remantle the unit as explained in § 7.2.

### 7.4 230 V OR 115 V POWER SUPPLY

To change the voltage, operate as follows:

- Switch the unit off, remove the power cord and disconnect the unit from any electrical connection.

- Open the upper casing as stated in § 7.1.
- Set the "voltage selector" to the desired position, see diagram above.
- Below the AC plug, set a label indicating the new value.

### 7.5 MAINTENANCE OF THE BATTERY

Models SN 8310-2 and SN 8310-4 are equipped with 12 V lead accumulators. The whole set is in the form of a tight and molded pack able to operate in any position. This battery pack does not require maintenance and checking charge state is only essential.

#### 7.5.1 Usual operation

When the unit is connected to the power supply, the indicator (~) comes on. Depending on discharge state, the built-in charger recharges the battery, the unit being in use or not.

During battery operation, the **BAT** message advises the user to recharge the battery.

In that state, the remaining life is approximately 20 %. Then, depending on usage, i.e. 30 or 90 minutes later, the unit switches off and it cannot be switched on again. **Recharge the battery to avoid any deterioration.**

For that, connect the unit to the power supply, the red indicator comes on and the battery is charging. Leave the battery on charge for 12 to 14 hours, unit switches off. Above that time, the charger automatically limits the current and the unit can remain connected to the power without any damage.

## 7.5.2 Storage

Respect the following rules to preserve battery life:

- Never store the unit with discharged battery.
- Recharge the battery after every period of use and before display of **BAT** message.
- Moreover, after automatic disconnection, storage of the unit in that state may alter the nominal capacity of the battery and break a part of the SN 8310 autonomy.

If the unit is to be stored for a long period, note that the self discharging current of a lead battery changes with the temperature, so that periodic recharges are necessary to compensate this self discharging.

- For a fully charged battery and storage temperatures below 25°C, do recharge the battery every 12 months.
- With storage temperatures between 30°C and 40°C, do recharge the battery every 6 months.

## 7.5.3 Replacing the battery

In case of abnormal operation on battery or if the autonomy is considerably reduced regarding that indicated in the technical specifications, the battery should be replaced (tight lead battery, 12 V, 1.8 to 2.0 Ah), AOIP part number: ER 41206-003.

## 7.6 CONNECTING THE RS 232 AND IEEE-488 INTERFACES TO THE GROUND

The common point of the RS 232, IEEE-488 interfaces together with the low point of logic circuits and terminals  $\text{⏏}$  at back and rear of the unit are referenced to the power cord security ground.

## 7.7 CYCLIC CHECKING OF PERFORMANCES

The specified performances have been checked at the factory before dispatch.

The user may require cyclic checking of the performances in order to keep track of the quality.

But this operation implies, as follows:

- Handling meeting reference conditions: temperature: 23°C ± 1°C, relative humidity: 45 % to 75 %.
- Known accuracy for the instruments used for checking and, for the SN 8310 above or equal to ± 0.0010 % over voltage ranges, ± 0.0025 % over current ranges and by taking the influence factors into account.

But, the unit should only be recalibrated if one or more characteristics are really outside the specified tolerances.

## 7.8 RECALIBRATION

### 7.8.1 Principle

After the correcting factors, stored in permanent memory (EEPROM), are applied, values of the output set points are sent to the digital-to-analog converter.

Recalibration is the operation which computes these factors.

All the output values come from a primary voltage source through the scaling circuits (reducer, amplifier, shunt...).

To the primary source are primary factors and, to each range, secondary factors.

Correction functions take the nominal values of components into account and calibration factors tell on the component errors regarding their nominal value.

To calibrate a range (or the primary source) the SN 8310 is asked to output two uncorrected values (one ranging 0.0 and the other close to the full scale), to measure the output values and then, to supply it with these four values.

Concerning the primary calibration (10 V range) and after the top and bottom of scale are calibrated, the IEEE and RS 232 interfaces correct the linearity thanks to a third value taken in middle of scale.

### 7.8.2 Method

According to the specified accuracies, the calibration must be performed at reference conditions by using the instruments specified in § 7.7.

When measuring the voltage and/or current delivered by the instrument to be calibrated, do care of the calibration method and instruments to be used in order to reduce the measurement incertitudes to the specified limits.

### 7.8.3 Keyboard procedure

#### 7.8.3.1 Access

- Place the required equipment and the unit to be calibrated in the regulated room and switch them on 24 h in advance.
- Get in programming function (see § 6.1 and 6.2), then confirm **CALIBRATE ?** prompt of the main menu.
- Follow procedure described below (see key in § 6.3).

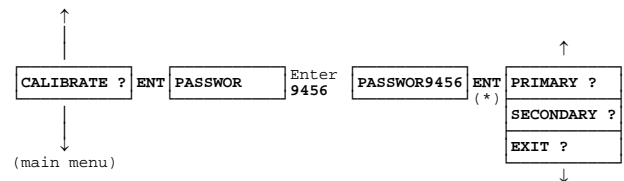

(\*) If wrong password, exit from programming function.

From this menu:

- either enter in calibration of 10 V primary range (reference range) by confirming the **PRIMARY ?** prompt,
- or enter in calibration of each range regarding the reference range by confirming the **SECONDARY ?** prompt,
- or exit from programming function by confirming the **EXIT ?** prompt.

*N.B: For a complete calibration (primary and secondary) do perform primary calibration first.*

### 7.8.3.2 Primary calibration

This calibration concerns the reference range and affects the other ranges of the unit.

Procedure is as follows:

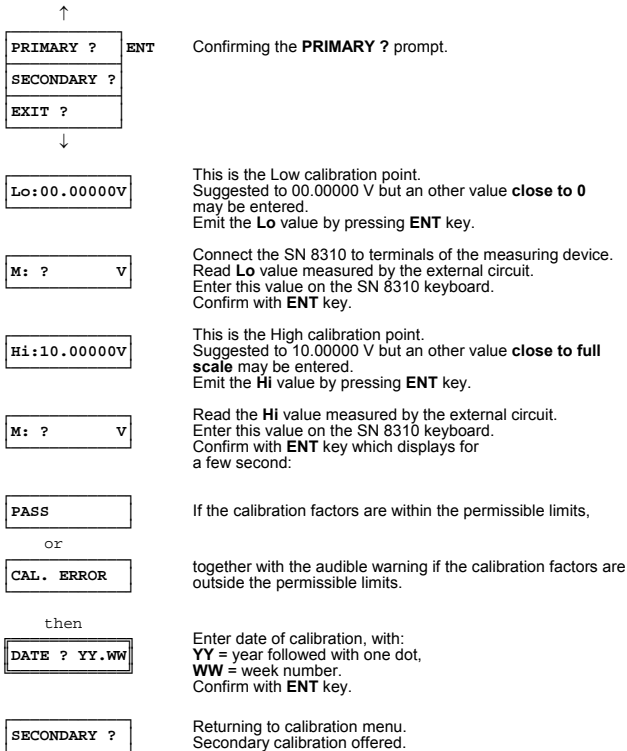

*N.B: The primary calibration is performed on keyboard by entering one low point (Lo) and one high point (Hi). But using the IEEE-488 and RS 232 interfaces performs it in three points (see § 5.12.3.8).*

*Calibration of negative values follows directly from calibration of positive values.*

### 7.8.3.3 Secondary calibration

This calibration concerns **each range of the unit** and can be performed either on all ranges, one by one, or only on the desired range.

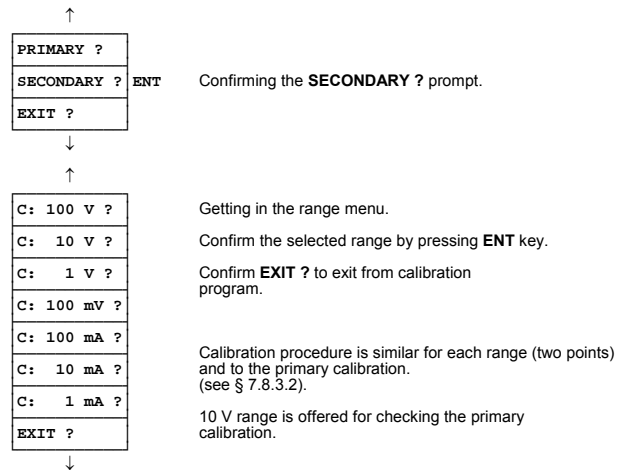

### 7.8.4 Calibration procedure from the RS 232 or IEEE-488 interfaces

Commands are described in § 5.12.3.8.

## 8. WARRANTY

The SN 8310 is fully warranted for one year in respect of defects which under proper use may appear in any parts and which are due to faulty manufacturing materials or workmanship, provided that no unauthorized modifications have been made on the unit.

If the unit is not operating correctly, it must be returned to the address below or to your local approved agency with respect to clauses in paragraph 4.2.

**AOIP INSTRUMENTATION**  
**Service Après-Vente**  
**Zone Industrielle de Saint-Guénault**  
**Rue Maryse Bastié**  
**B.P 182 - 91006 EVRY CEDEX - FRANCE**

Tel: +33 1 69 36 50 50